

DEFENDER

SKILL LEVEL 2
FOR INTERMEDIATE ROCKETEERS

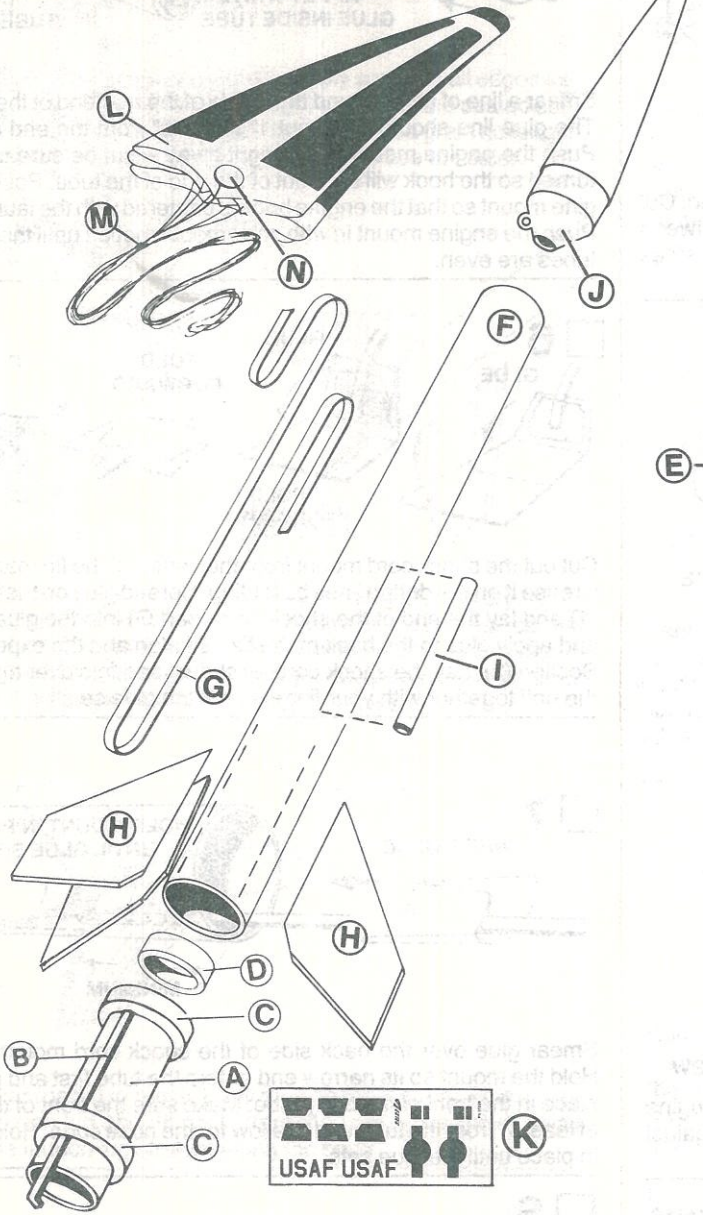
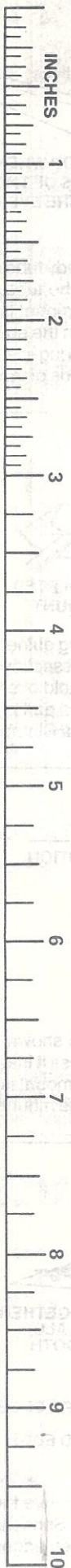

RECOMMENDED ENGINE: D12-5

TOOLS AND MATERIALS

In addition to the parts included in this kit you will need: Scissors, pencil, ruler, fine or extra-fine grit sandpaper, sanding sealer, a medium-size modeling paint brush, masking tape, modeling knife with sharp blade, flat blue and gloss white enamel spray paints, and household white glue or resin glue (Elmer's, Titebond, or similar). Other types of glue are not recommended.

For easy and positive alignment of the fins on your model, we recommend the use of Estes' Fin Alignment Guide, Part No. 2231.

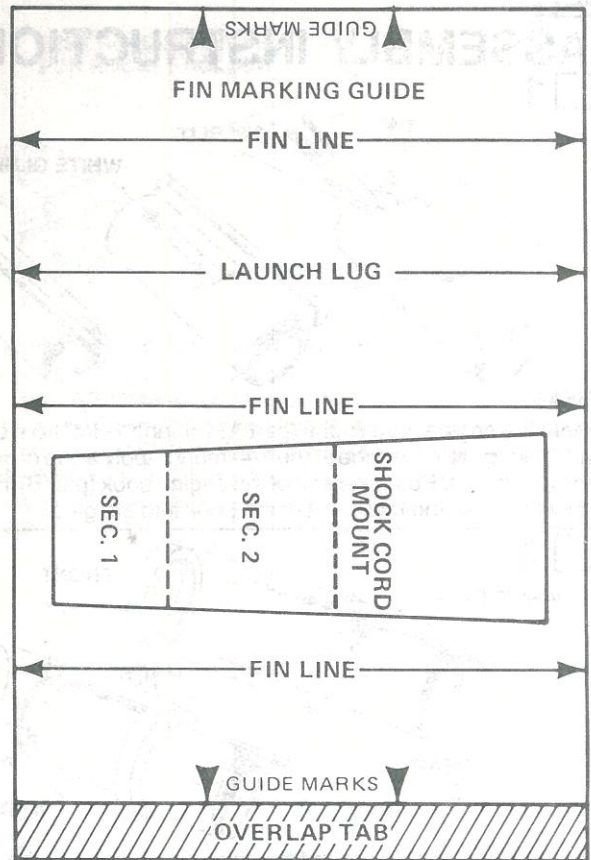

A DAMON COMPANY

ESTES INDUSTRIES
PENROSE, CO 81240 USA

BEFORE YOU START

Read each step and study the accompanying drawings before doing any of the work called for in that step. Make sure you have all parts and materials. Check off each step as you complete it. Always test-fit parts together before applying glue. It will sometimes be necessary to sand edges of rings, tubes, etc. to obtain proper fit. If you are in doubt about the relative size or location of some parts, refer back to this exploded view drawing for clarification. Adequate glue joints are very important for a flying model rocket. Follow the instructions carefully in this respect.

PARTS LIST

KIT #1924

A	1 Engine Mount Tube (type BT-50J)	30362
B	1 Engine Hook (type EH-2)	35025
C	2 Adapter Rings (type AR-5055)	30166
D	1 Engine Block (type AR-2050)	30164
E	1 Body Marking Guide	83692
F	1 Body Tube (type BT-55)	30382
G	1 Shock Cord (type SC-1)	85730
H	1 Die-Cut Balsa Sheet (type BF-1906)	32606
I	1 Launch Lug (type LL-2B)	38178
J	1 Plastic Nose Cone (type PNC-55AC)	71070
K	1 Decal Sheet (type KD-1924)	37239
L	1 12" Parachute (type PK-12A)	85564
M	1 Shroud Line (type SLT-72)	38237
N	1 Tape Disc (type TD-3F)	38406

ASSEMBLY INSTRUCTIONS

1

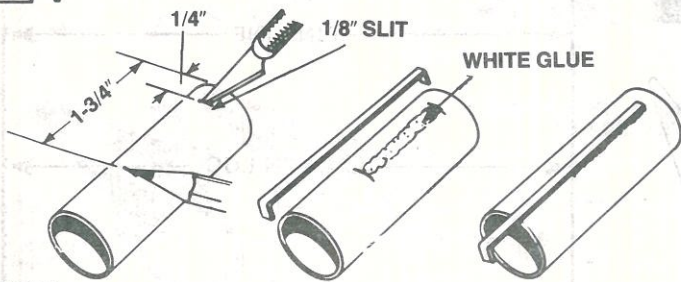

REAR

Mark the engine mount tube (part A) 1/4" and 1-3/4" from one end. Cut a 1/8" long slit in the tube at the 1/4" mark. Apply a line of glue between the two marks. Push one end of the engine hook (part B) into the slit as shown. Press the main part of the hook into the glue.

2

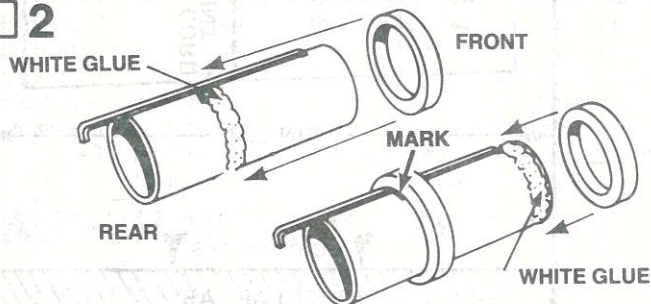

Apply a line of glue around the tube just forward of the 1-3/4" mark. Slide one of the adapter rings (part C) onto the tube from the forward end, over the engine hook, and up to the 1-3/4" mark. Apply a line of glue around the tube just forward of the engine hook. Slide the remaining adapter ring onto the forward end of the tube until it just touches the engine hook.

3

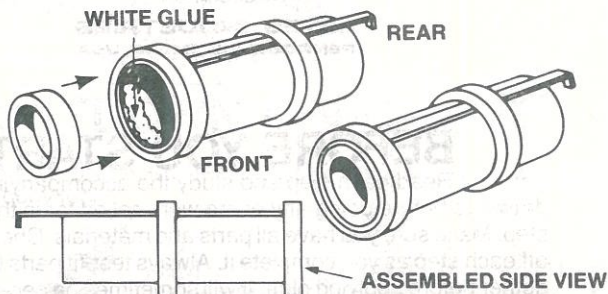

Smear a line of glue around the inside of the forward end of the engine mount tube and push the engine block (part D) in until it stops against the engine hook. Set the unit aside to dry.

4

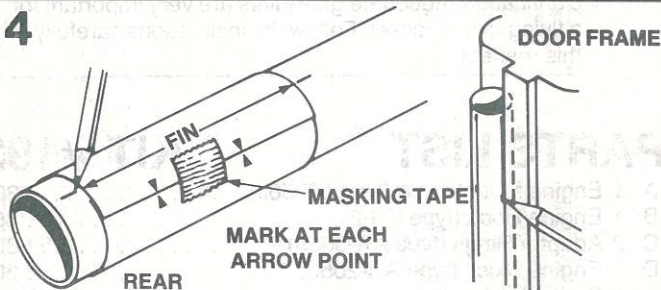

Cut out the body marking guide (part E) from the front of the instruction sheet. Wrap it around one end of the rocket body tube (part F). Match the printed guide marks and tape guide in place. Mark the tube at each arrow point. Remove the guide. Place the body tube against the inside edge of a door frame as shown. Draw a line about 4" long from the tube end through each pair of fin line marks. Draw a line the entire length of the body tube through the launch lug marks. Label this launch lug line. You may prefer to use a ruler to connect the tube marks and draw the alignment lines.

5

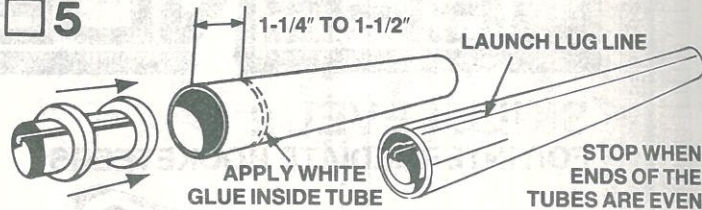

Smear a line of glue around the inside of the rear end of the body tube. The glue line should be about 1" to 1-1/2" from the end of the tube. Push the engine mount unit in right away -- but be sure the mount is turned so the hook will stick out of the end of the tube. Position the engine mount so that the engine hook is centered with the launch lug line. Push the engine mount in with one smooth motion until the ends of the tubes are even.

6

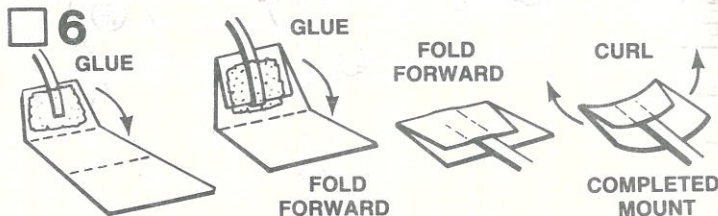

Cut out the shock cord mount from the center of the fin marking guide. Crease it on the dotted lines by folding. Spread glue on the first section (1) and lay the end of the shock cord (part G) into the glue. Fold over and apply glue to the back of the first section and the exposed part of Section (2). Lay the shock cord as shown and fold over again. Clamp the unit together with your fingers until the glue sets.

7

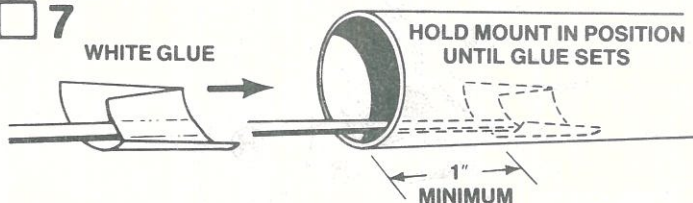

Smear glue over the back side of the shock cord mount as shown. Hold the mount so its narrow end enters the tube first and press it into place in the front of the body tube. Make sure the front of the mount is at least 1" from the tube end to allow for the nose cone. Hold the mount in place until the glue sets.

8

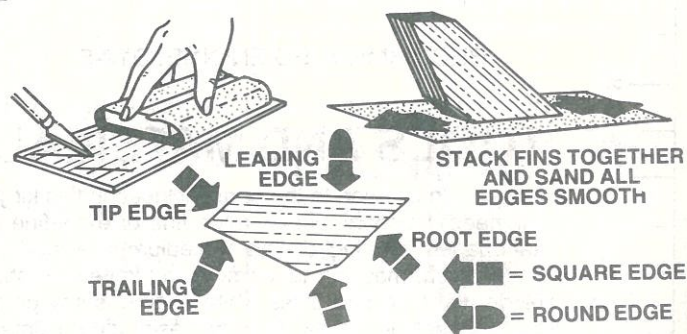

Fine-sand the balsa die-cut sheet (part H), then carefully remove the die-cut fins from the sheet. Free the edges with a sharp knife. Sand the leading and trailing edges of the fins round. Leave other edges square.



9 **APPLY 2 COATS OF SANDING SEALER**

LIGHTLY SAND ALL FIN'S AFTER SEALER HAS DRIED

Apply a coat of sanding sealer to each fin. Apply sealer to all edges except the root edge. When sealer is dry, lightly sand all the sealed surfaces. Repeat sealing and sanding process until balsa grain no longer shows. Resand root edge, lightly, to remove any trace of sealer.

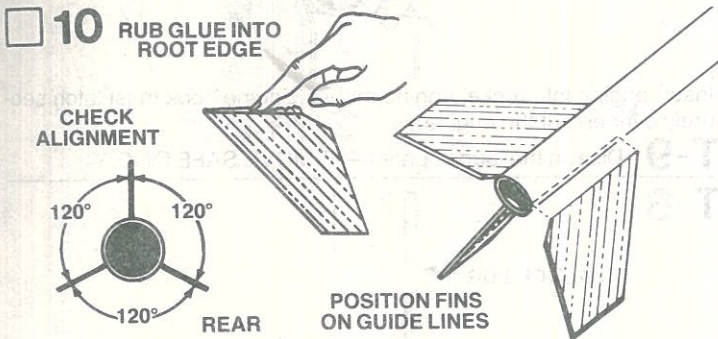

10 **RUB GLUE INTO ROOT EDGE**

CHECK ALIGNMENT

120° 120° 120°

REAR

POSITION FIN'S ON GUIDE LINES

Rub a line of glue into the root edge of each fin and allow to dry. Apply glue to the fins and position fins on the alignment lines in their correct positions on the tube. Refer to the illustration to be sure of these positions. Adjust the fins so they project straight away from the body tube. Do not set the rocket on its fins while the glue is wet.

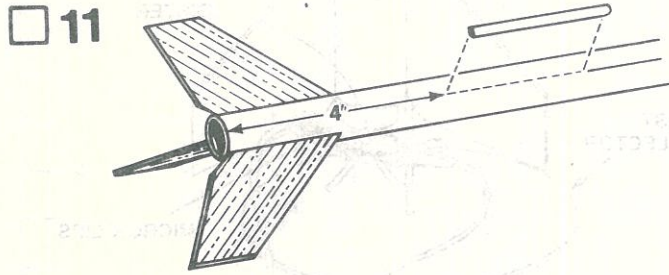

11

Glue launch lug (part I) to rocket body tube on the launch lug line. The rear of the launch lug should be 4" from the rear of the rocket body tube. Align the launch lug straight along the body.

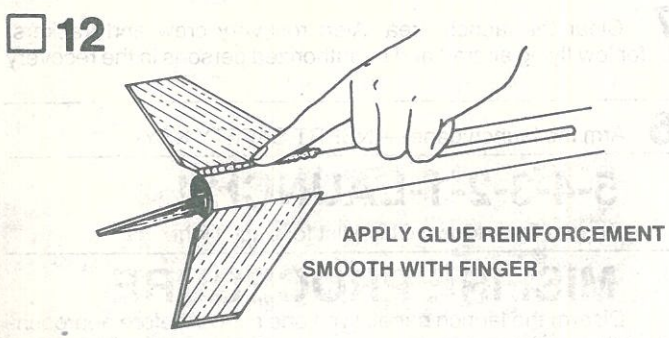

12

APPLY GLUE REINFORCEMENT SMOOTH WITH FINGER

Apply glue reinforcements to each fin/body tube joint. Holding the model level, apply a narrow line of glue to both sides of each fin joint. Smooth out the glue with your finger. Apply glue reinforcement on both sides of launch lug. **IMPORTANT**—Keep the model level until the glue dries.

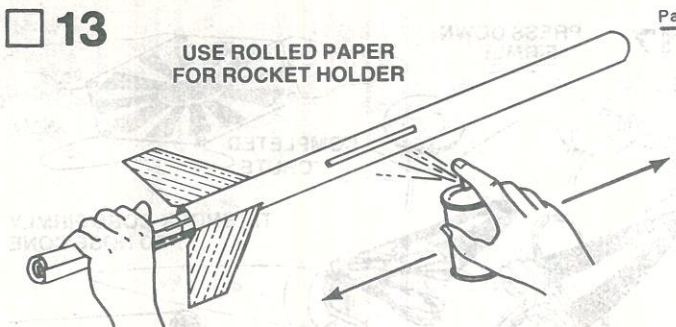

13 **USE ROLLED PAPER FOR ROCKET HOLDER**

After all the glue is completely dry, paint the entire rocket body and fins with gloss white spray enamel. Follow instructions on the spray can for best results. We recommend spray enamel. Do not paint the model with lacquer paint. Shake can before spraying. Hold the can straight up and spray in long smooth "strokes". Spray the model with several light dry mist coats of paint to avoid "runs". Shake can periodically. To obtain a gloss, final coat should be applied slightly heavier. Let this coat dry overnight.

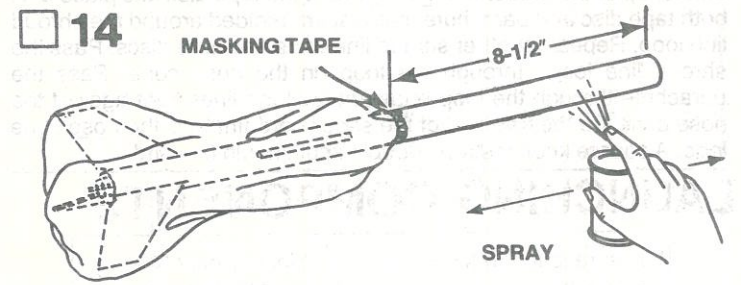

14 **MASKING TAPE**

8-1/2"

SPRAY

PAPER OR PLASTIC BAG

Apply masking tape and paper to cover and protect the areas which will remain white. (See the Decor Layout illustration.) Paint the forward 8-1/2" of the body tube flat blue. Carefully remove the masking tape and paper as soon as the paint is dry.

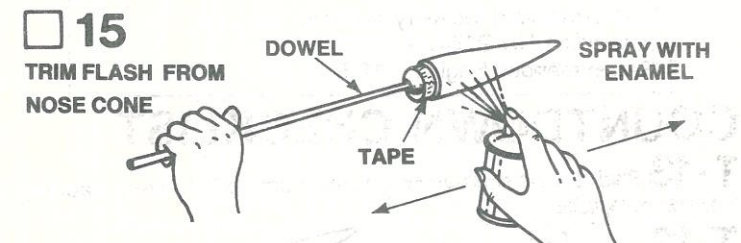

15 **TRIM FLASH FROM NOSE CONE**

DOWEL

TAPE

SPRAY WITH ENAMEL

Spray paint the nose cone (part J) with several light coats of flat blue paint. The nose cone can be supported by a dowel or stick inserted in the center opening in the nose cone while being painted and drying. A layer of masking tape around nose cone shoulder works well to protect the nose cone shoulder from "overspray" while painting.



16

When all paint is dry, apply the decals (part K) in the positions shown. (A) Cut only one decal at a time from sheet. (B) Submerge decal in lukewarm water until decal slides on backing paper (usually 15 to 30 seconds). (C) Gently slide decal from backing paper onto model. (D) Move decal into exact position and carefully blot away excess water with a soft cloth. (E) If the decal "sticks" before you have it in position apply water over the decal with a brush. This will permit the decal to be moved. (F) Smooth out all wrinkles and air bubbles before the decal dries. We recommend that the completed model be sprayed with Testor's "Dull-Cote". This is a flat clear spray paint that protects the model's finish.

17
TAPE DISC

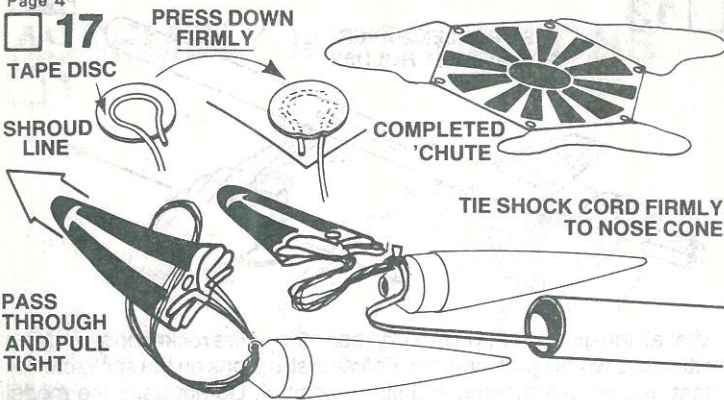

Cut out the parachute (part L) on its edge lines. Cut three equal lengths of shroud line (part M). Attach line ends to the top of the parachute with tape discs (part N) as shown. Form a small loop in the end of a shroud line. Holding loop, gently center loop inside tape disc on the sticky side. Then carefully press tape disc onto its proper place on the top of the parachute. Firmly press the tape disc into place until both tape disc and parachute material are molded around the shroud line loop. Repeat for other shroud line ends and tape discs. Pass the shroud line loops through the loop on the nose cone. Pass the parachute through the loop ends and pull the lines tight against the nose cone. Tie the free end of the shock cord firmly to the nose cone loop. A square knot or strong double knot should be used.

LAUNCHING COMPONENTS

Be sure to follow the HIAA-NAR* Model Rocket Safety Code when carrying out your model rocket activities.
*HIAA—Hobby Industry of America
*NAR—National Association of Rocketry

To launch your model you will need the following items:
An Estes model rocket launch system
Flame-resistant recovery wadding
(Estes Cat. No. 2274)
Recommended Engine: D12-5

COUNTDOWN CHECKLIST

T-13 Pack 5 or 6 squares of loosely crumpled recovery wadding into the body tube.

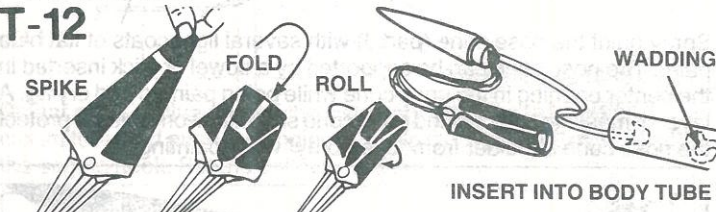

Hold the parachute at its center and pass the other hand down it to form a "spike" shape. Fold this spike in half. Roll parachute into tube shape to fit easily into body. Pack chute into the tube on top of the wadding. Pack the shroud lines and shock cord in on top of the parachute and slip the nose cone into place.

NOTE: DO NOT pack parachute until you are actually ready to launch. For maximum parachute reliability, lightly dust the chute with ordinary talcum powder before each flight, especially in cold weather.

NOTE: Nose cone should separate easily from rocket body tube, but should not be extremely loose. If fit is too tight, sand inside of body tube and shoulder of nose cone with fine sandpaper. If fit is too loose, add a wrapping of transparent tape or masking tape to the shoulder of the nose cone.

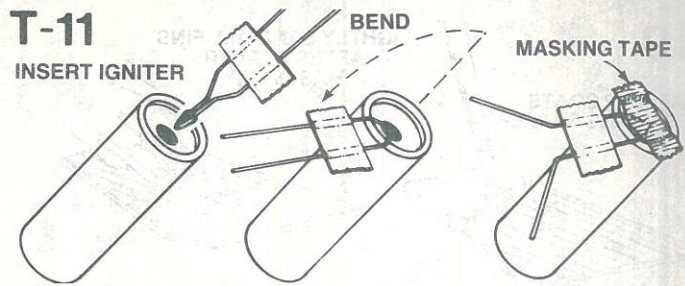

Select an engine and install an igniter as directed in the engine instructions. Use a D12-5 engine only.

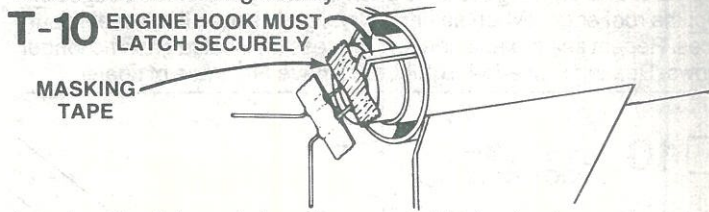

Insert engine into rocket engine mount. Engine hook must latch securely over end of the engine.

T-9 Disarm the launch panel—REMOVE SAFETY KEY!

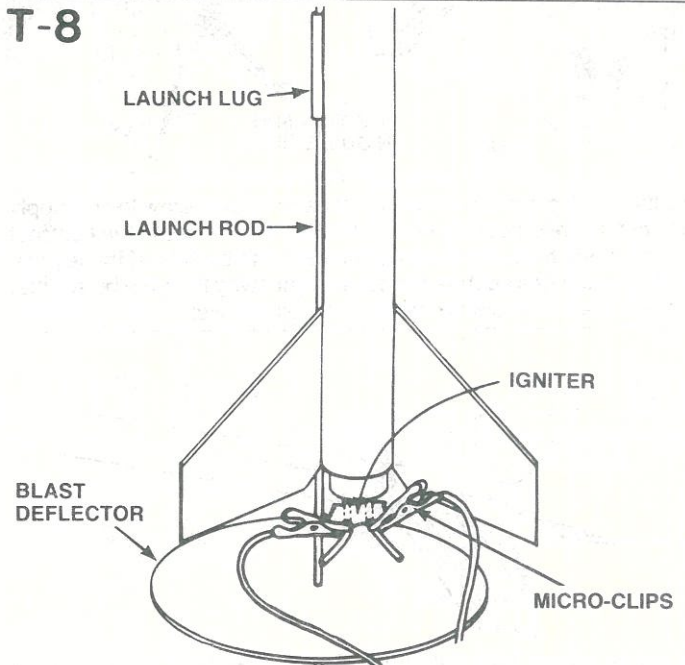

Slide launch rod through rocket launch lug and place rocket on launch pad. Make sure the rocket slides freely on the launch rod. Clean the micro-clips and attach them to the igniter wires. Arrange the clips so they do not touch each other or the metal blast deflector. Attach clips as close to protective tape on igniter as possible.

T-7 Clear the launch area. Alert recovery crew and trackers. Check for low flying aircraft and unauthorized persons in the recovery area.

T-6 Arm the launch panel—INSERT SAFETY KEY!

5-4-3-2-1-LAUNCH!!

Repeat Countdown Checklist for each flight.

MISFIRE PROCEDURE

Disarm the launch panel. Wait one minute before approaching the rocket on the launch pad. Remove the rocket, clean the igniter residue from the nozzle of the engine, and carefully install a new igniter. Repeat the Countdown Checklist.

Failure of the rocket engine to function properly is nearly always caused by a failure to install the igniter correctly. This failure permits the igniter to heat and burn into two pieces without igniting the engine.