



# LAUNCHABLES™

READY TO FLY MODEL ROCKET INSTRUCTIONS

KEEP FOR FUTURE REFERENCE

www.estesrockets.com

ESTES-COX CORP.

1295 H Street

Penrose, CO 81240

PRINTED IN CHINA

**LAUNCH TIP:** Read all instructions before launching your model. Make sure you have all supplies. Rocket color and shape may vary.

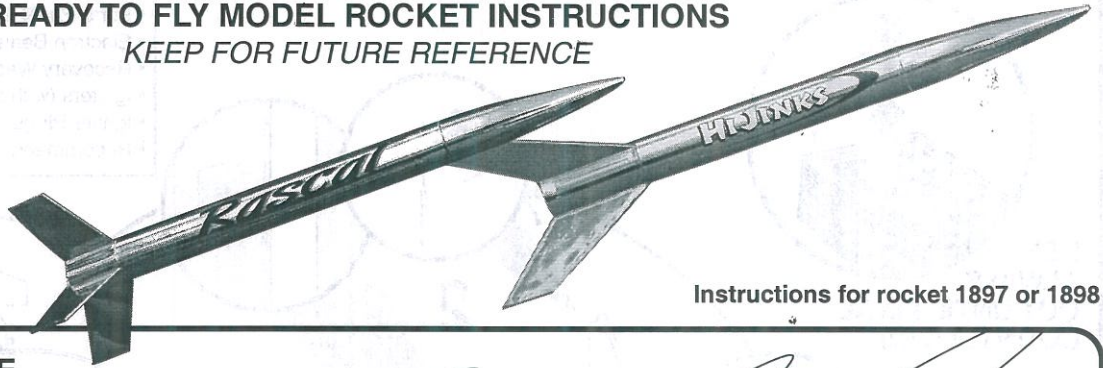

Instructions for rocket 1897 or 1898

## 1. ATTACH PARACHUTE

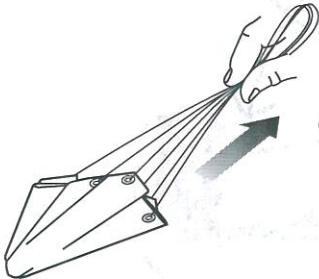

A. Form a loop with the parachute shroud lines.

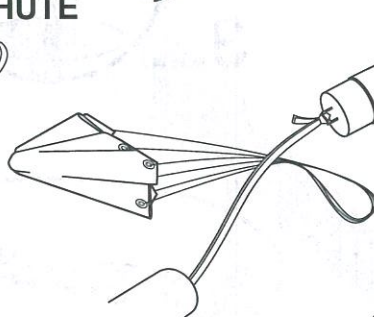

B. Lay shock cord over loop.

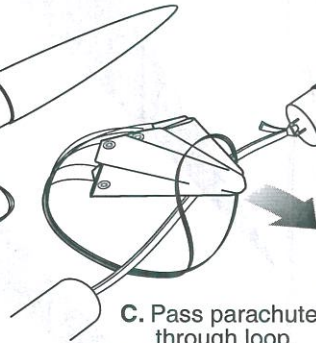

C. Pass parachute through loop.

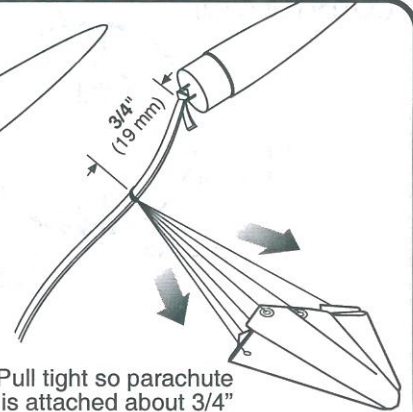

D. Pull tight so parachute is attached about 3/4" (19 mm) from nose cone.

## 2. PREPARE PARACHUTE

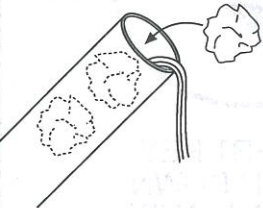

A. Insert 3 squares of loosely crumpled recovery wadding into rocket.

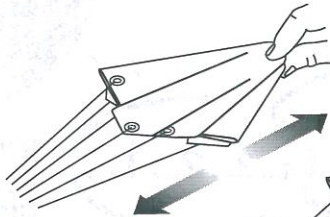

B. Spike parachute.

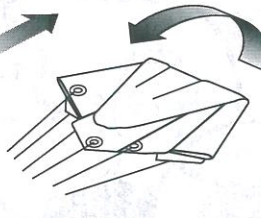

C. Fold.

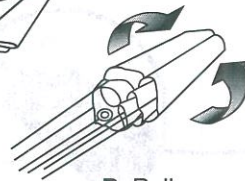

D. Roll.

**IMPORTANT:** Parachute should slide easily into body. If fit is too tight, unfold and repack again.

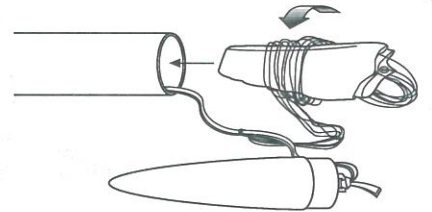

E. Wrap lines loosely. Insert chute, shock cord and nose cone into body tube.

**IMPORTANT:** Wadding must be in place and slide freely for recovery system to work properly.

**NOTE:** Only Estes Wadding (302274) Recommended.

**HELPFUL HINT: IF NOSE CONE FIT IS...**

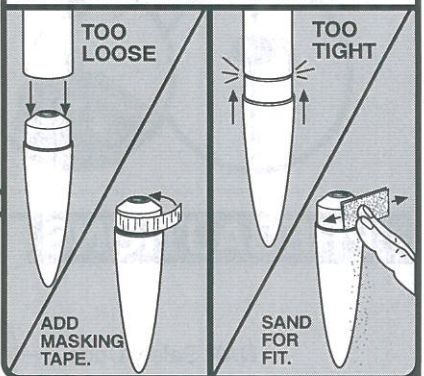

## 3. PREPARE ENGINE

### ⚠ WARNING: FLAMMABLE

To avoid serious injury, read instructions & NAR Safety Code included with engines.

**PREPARE ENGINE ONLY WHEN YOU ARE OUTSIDE AT THE LAUNCH SITE PREPARING TO LAUNCH!**

If you do not use your prepared engine, remove the igniter before storing engine.



A. Separate igniter and plug.



B. Insert igniter.

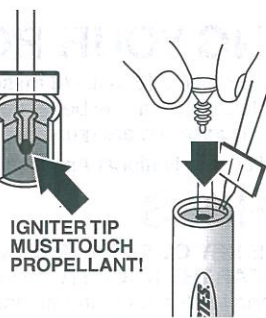

C. Insert igniter plug. Firmly push all the way in!



D. Push down.



E. Gently bend igniters to form leads as shown.

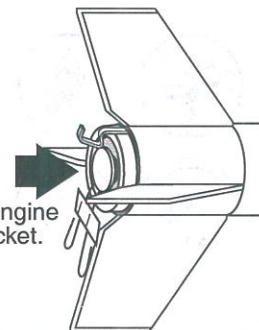

F. Insert engine into rocket.



## COUNTDOWN AND LAUNCH

## ESTES LAUNCH SUPPLIES

(Sold Separately)

- Porta Pad® II Launch Pad
- Electron Beam® Launch Controller
- Recovery Wadding (included with some engines)
- Igniters (with engines)
- Igniter Plugs (with engines)
- Recommended Engines: A8-3, B4-4, B6-4, C6-5, C6-7

**KEY ALWAYS OUT UNTIL FINAL COUNTDOWN!**

**1...**

MASKING TAPE



**2...**

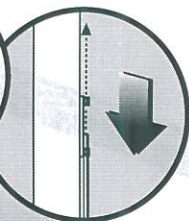

**3...**

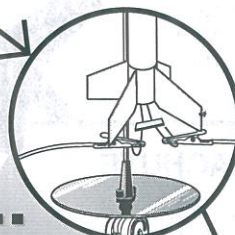

**4...**



**5...**

4... 3... 2... 1...

**INSERT KEY. PUSH DOWN FIRMLY AND HOLD.**

**HOLD KEY DOWN AND PRESS LAUNCH BUTTON UNTIL LIFTOFF!**

## PRECAUTIONS

NAR Safety Code



**NO DRY GRASS OR WEEDS**

**PRE-LAUNCH CHECK** For safety, never launch a damaged rocket. Check the rocket's body, nose cone and fins. Also, check the engine mount, recovery system and launch lug(s). Repair any damage before launching the rocket.

## FLYING YOUR ROCKET

Choose a large field (250 ft. [76 m] square) free of dry weeds and brown grass. The larger the launch area, the better your chance of recovering your rocket. Football fields and playgrounds are great. Launch only with little or no wind and good visibility. Always follow the National Association of Rocketry (NAR) SAFETY CODE.

## MISFIRES

**TAKE THE KEY OUT OF THE CONTROLLER. WAIT ONE MINUTE BEFORE GOING NEAR THE ROCKET!** Disconnect the igniter clips and remove engine. Take the plug and igniter out of the engine. If the igniter has burned, it worked but did not ignite the engine because it was not touching the propellant inside the engine. Put a new igniter all the way inside the engine without bending it. Push the plug in place. Repeat the steps under Countdown and Launch.