



www.estesrockets.com
 ESTES-COX CORP.
 1295 H Street
 Penrose, CO 81240
 PRINTED IN CHINA

PUMA™

READY TO FLY MODEL ROCKET INSTRUCTIONS

KEEP FOR FUTURE REFERENCE

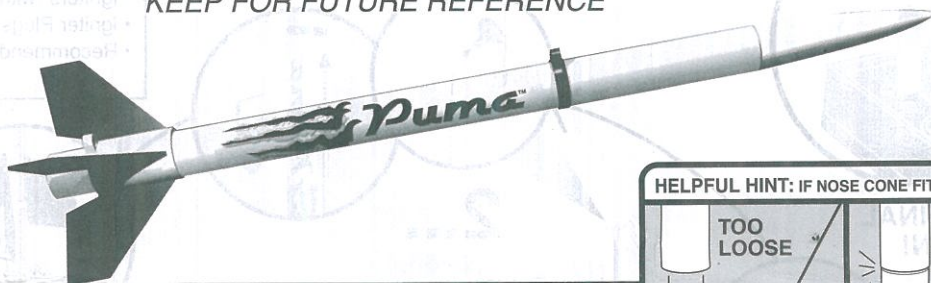

#1896

ASSEMBLY TIP: Read all instructions before beginning work on your model. Make sure you have all parts and supplies.

HELPFUL HINT: IF NOSE CONE FIT IS...

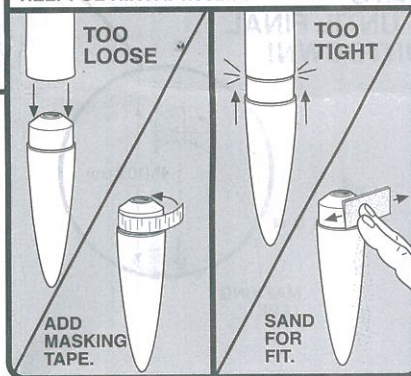

1. STREAMER ATTACHMENT

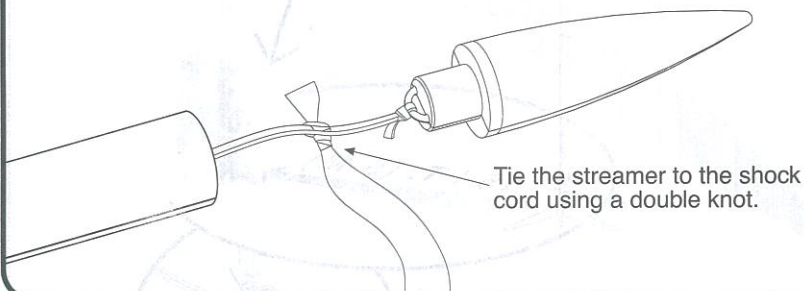

2. RECOVERY SYSTEM PREP

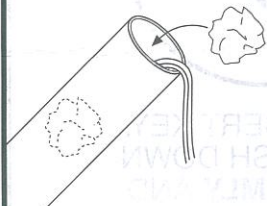

A. Insert 2 squares of loosely crumpled recovery wadding into rocket.

IMPORTANT: Wadding must be in place and slide freely for rocket to work properly.

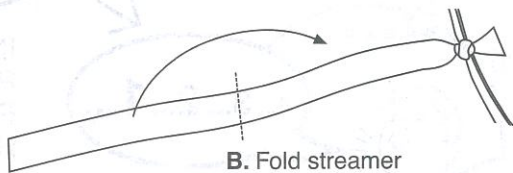

B. Fold streamer in half.

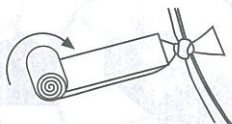

C. Roll streamer.

IMPORTANT: Streamer should slide easily into body. If fit is too tight, unfold and repack again.

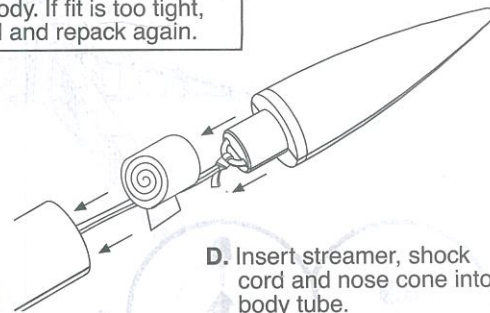

D. Insert streamer, shock cord and nose cone into body tube.

NOTE: Only Estes Wadding (302274) Recommended.

3. ENGINE PREP

WARNING: FLAMMABLE

To avoid serious injury, read instructions & NAR Safety Code included with engines.

PREPARE ENGINE ONLY WHEN YOU ARE OUTSIDE AT THE LAUNCH SITE

PREPARING TO LAUNCH! If you do not use your prepared engine, remove the igniter before storing engine.



A. Separate igniter and plug.



B. Insert igniter.

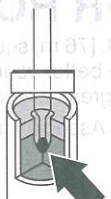

IGNITER TIP MUST TOUCH PROPELLANT!

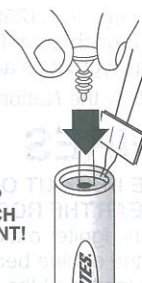

C. Insert igniter plug. Firmly push all the way in!



D. Push down.

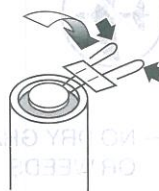

E. Gently bend igniters to form leads as shown.

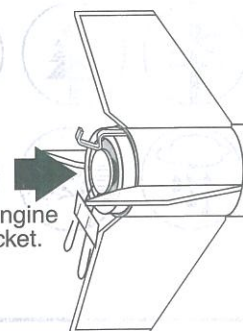

F. Insert engine into rocket.

COUNTDOWN AND LAUNCH

ESTES LAUNCH SUPPLIES

(Sold Separately)

- Porta Pad® II Launch Pad
- Electron Beam® Launch Controller
- Recovery Wadding (included with some engines)
- Igniters (with engines)
- Igniter Plugs (with engines)
- Recommended Engines: 1/2A3-2T, 1/2A3-4T, A3-4T, A10-3T

KEY ALWAYS OUT UNTIL FINAL COUNTDOWN!

1...

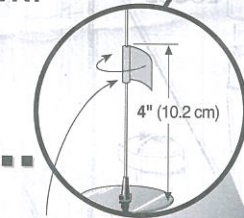

MASKING TAPE

2...



3...

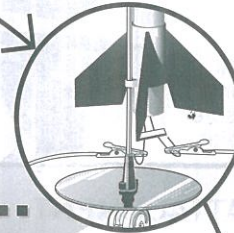

4...



KEY

5...

4... 3... 2... 1...

INSERT KEY. PUSH DOWN FIRMLY AND HOLD.

HOLD KEY DOWN AND PRESS LAUNCH BUTTON UNTIL LIFTOFF!

PRECAUTIONS

NAR Safety Code



NO DRY GRASS OR WEEDS

PRE-LAUNCH CHECK

For safety, never launch a damaged rocket. Check the rocket's body, nose cone and fins. Also, check the engine mount, recovery system and launch lug(s). Repair any damage before launching the rocket.

FLYING YOUR ROCKET

Choose a large field (250 ft. [76 m] square) free of dry weeds and brown grass. The larger the launch area, the better your chance of recovering your rocket. Football fields and playgrounds are great. Launch only with little or no wind and good visibility. Always follow the National Association of Rocketry (NAR) SAFETY CODE.

MISFIRES

TAKE THE KEY OUT OF THE CONTROLLER. WAIT ONE MINUTE BEFORE GOING NEAR THE ROCKET! Disconnect the igniter clips and remove engine. Take the plug and igniter out of the engine. If the igniter has burned, it worked but did not ignite the engine because it was not touching the propellant inside the engine. Put a new igniter all the way inside the engine without bending it. Push the plug in place. Repeat the steps under Countdown and Launch.