



www.estesrockets.com

ESTES INDUSTRIES  
1295 H Street  
Penrose CO 81240  
PRINTED IN CHINA

# SUPER SHOT™ RACE SET

## MINI FLYING MODEL ROCKET INSTRUCTIONS

KEEP FOR FUTURE REFERENCE

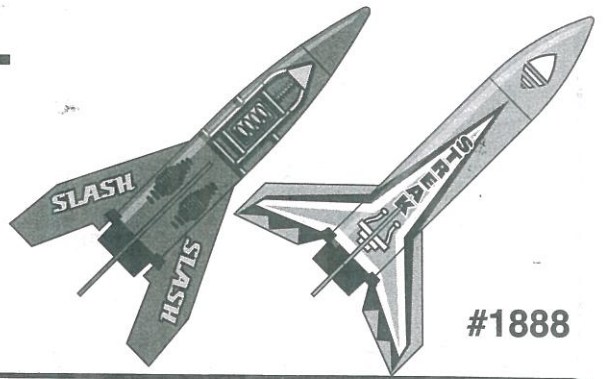

#1888

**ASSEMBLY TIP:** Read all instructions before beginning work on your model. Make sure you have all parts and supplies.

Use these instructions for each of your Super Shot™ rockets.

### 1. ATTACH STREAMER

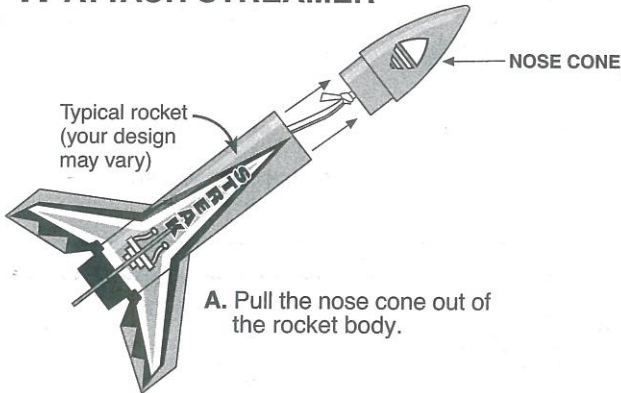

A. Pull the nose cone out of the rocket body.

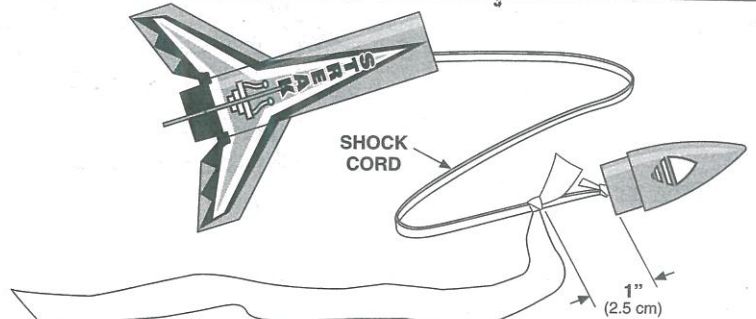

B. Measure 1" (2.5 cm) from the nose cone and tie streamer to shock cord with a double knot.

**IMPORTANT:** Do NOT attach a streamer to the "SLASH" rocket.

### 2. PREPARE STREAMER FOR FLIGHT

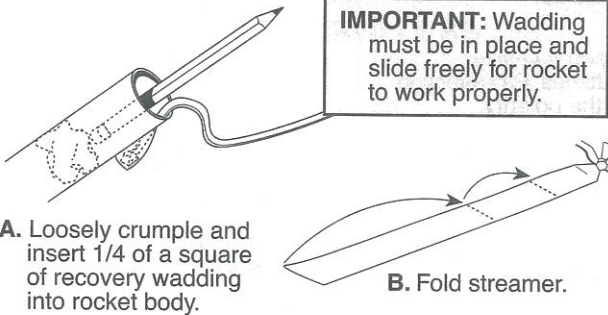

A. Loosely crumple and insert 1/4 of a square of recovery wadding into rocket body.

B. Fold streamer.

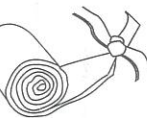

C. Roll.

D. Wrap shock cord loosely around streamer. Insert streamer into rocket. Streamer should slide easily into body tube. If fit is too tight, unfold and repack.

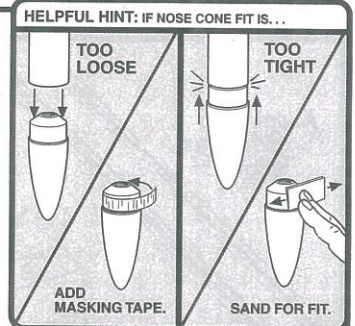

**IMPORTANT:** For "SLASH" rocket, insert wadding and shock cord into rocket body tube.

### 3. PREPARE ENGINE FOR FLIGHT

**WARNING : FLAMMABLE**  
To avoid serious injury, read instructions & NAR Safety Code included with engines.  
**PREPARE YOUR ENGINE ONLY WHEN YOU ARE OUTSIDE AT THE LAUNCH SITE PREPARING TO LAUNCH!**  
If you do not use your prepared engine, remove the igniter before storing your engine.

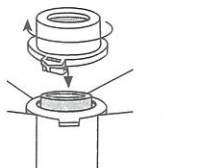
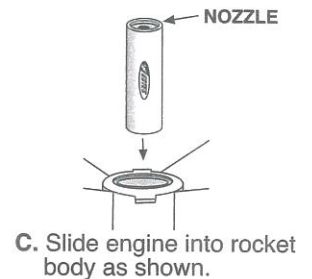
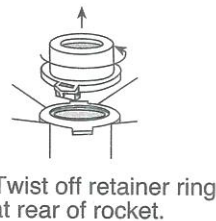

D. Twist retainer ring into locked position to hold engine in place.



F. Insert igniter plug.

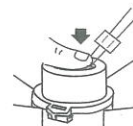

G. Firmly push igniter plug all the way in.



H. Gently bend igniter wires as shown.

## LAUNCH PAD (FOR MINI ENGINE ROCKETS ONLY)

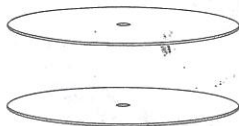

BLAST DEFLECTOR (2)  
(60121)

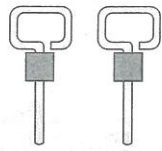

SAFETY KEY (2)  
(38101)

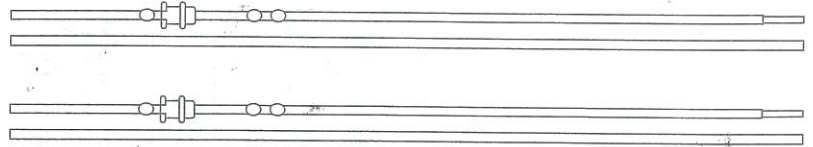

LAUNCH ROD  
(2 pieces) (2 sets)  
(60137)



SAFETY CAP (2)  
(60139)



DUELING LAUNCH PAD (1)  
(61222)

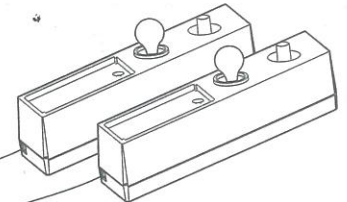

LAUNCH CONTROLLERS (2)  
(61223)

## SUPPLIES REQUIRED:



PHILLIPS SCREWDRIVER



SAND PAPER



MASKING TAPE

### 1. JOIN LAUNCH RODS

A. Join two pieces as shown.

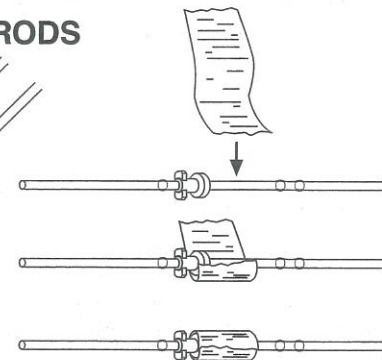
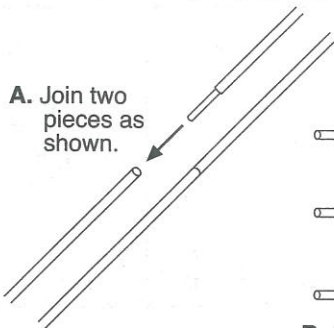

B. Secure the plastic rod lock with a piece of masking tape as shown to protect it during the next step.

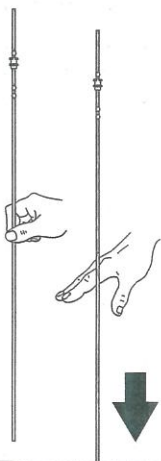

CONCRETE FLOOR

C. Drop rod repeatedly on concrete floor until joint is tight. Remove tape.

D. Sand the joint and both ends smooth with light grade sandpaper.

### 2. INSTALL BATTERIES

A. Lift latch and open race case.

B. Remove screws from top of battery compartment and lift off lid.

C. Insert 4 D-size batteries. Pay attention to the polarity. A "+" and "-" are marked on the bottom of each cavity.

D. Replace lid. Insert and tighten screws.

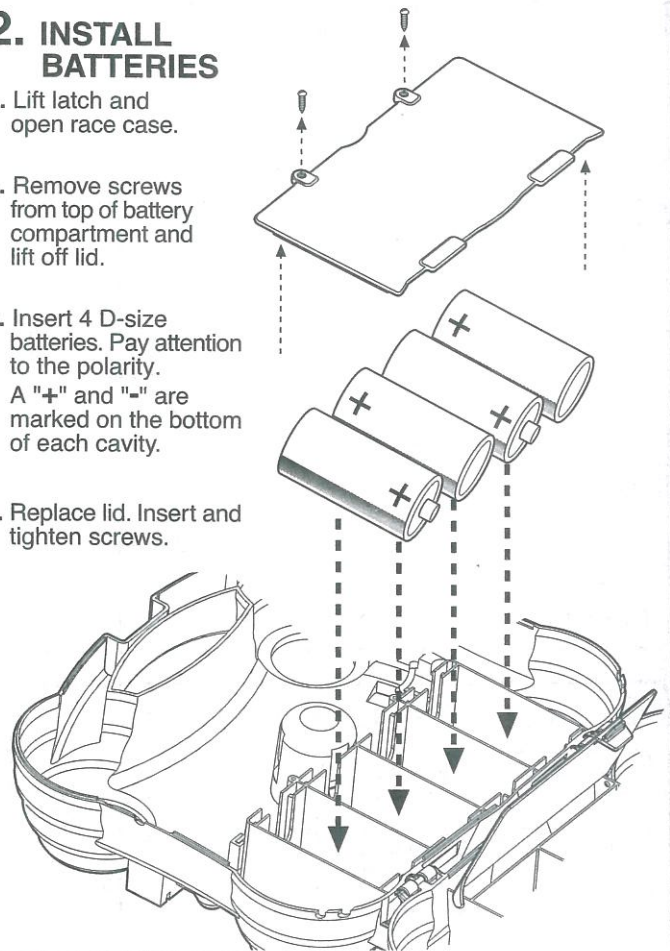

#### CAUTION:

- Use only alkaline batteries
- Insert batteries into unit in the correct polarity.
- Do not use rechargeable batteries in the unit.
- Do not mix alkaline, standard (carbon - zinc) or rechargeable batteries.
- Do not mix old and new batteries.
- Remove old or dead batteries from unit.
- If unit will be stored for long periods, remove batteries.
- Never recharge non-rechargeable batteries.
- Only batteries of the same or equivalent type recommended are to be used.
- Do not short-circuit supply terminals.



### 3. ATTACH LAUNCH RODS AND BLAST DEFLECTORS

#### SAFETY NOTES:

1. Always place safety cap on launch rod when not in use.
2. Do not stand directly over launch pad.
3. Fly only Estes model rockets that use mini engines from this launch pad! Do not attempt to fly any other any rockets off of this launch pad.

A. Slide the swaged end of the launch rod into the slot in top of race case. Make sure rod rests in base socket.

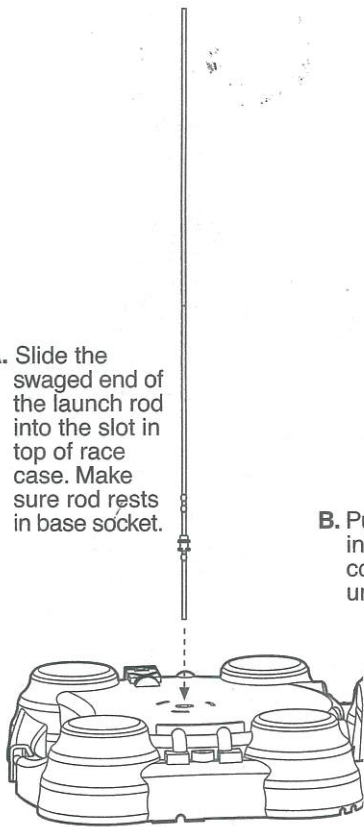

B. Push plastic rod lock into the slot. Twist it counter clockwise until it stops.

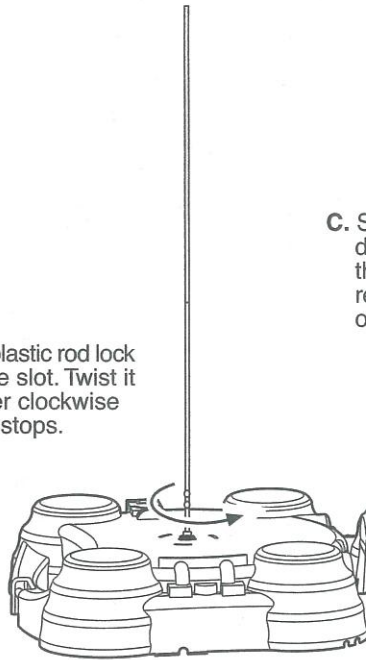

C. Slide the blast deflector down the rod until it rests flat on top of the case.

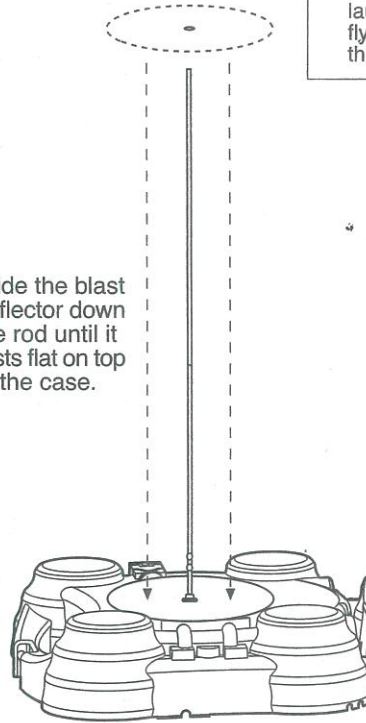

D. Place the safety cap on the launch rod.

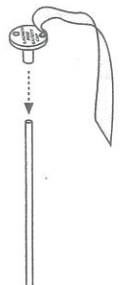

E. Repeat for other launch rod and blast deflector.

### 4. TEST BOTH CONTROLLERS



A. Clip micro-clips together. Continuity light will not glow without the safety key in place and held down. If it does, do not use the controller. Return set to Estes for a replacement.

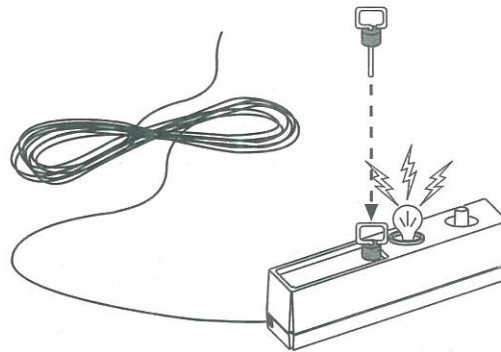

B. Insert safety key. Press and **FIRMLY HOLD** safety key **DOWN**. Continuity light should glow with a bright white light. (A dim yellow light indicates weak batteries.)

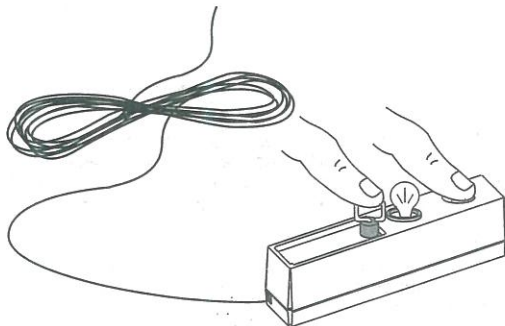

C. While holding safety key down, press and hold down the launch button. The continuity light will go out while the launch button is depressed. Immediately release launch button. Test complete.

If one or both controllers does not behave as described above, check the following:

- Make sure the micro-clips are firmly clipped together.
- Remove the safety key and reinsert it. (Remember that if your launch controller is connected to a rocket, the safety key should only be inserted when no one is near the rocket.)
- Make sure batteries are charged and properly installed.
- If the launch controller still does not function correctly, please see the enclosed warranty.



# COUNTDOWN AND LAUNCH

## ESTES LAUNCH SUPPLIES

(Sold Separately)

- Recovery Wadding (included with some engines)
- Igniters (with engines)
- Igniter Plugs (with engines)
- Recommended Engines: 1/4A3-3T, 1/2A3-4T, A3-4T, A10-3T

### IMPORTANT:

Before each launch, check that the launch rod is smooth and straight - especially at the joint. Use sandpaper or steel wool to smooth joint and remove engine residue from rod. Gently straighten rod if bent.

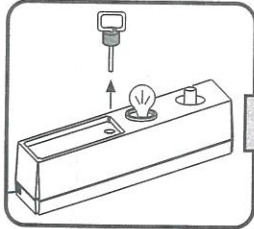

KEY ALWAYS OUT UNTIL FINAL COUNTDOWN!

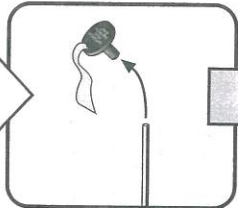

REMOVE SAFETY CAPS FROM LAUNCH RODS.

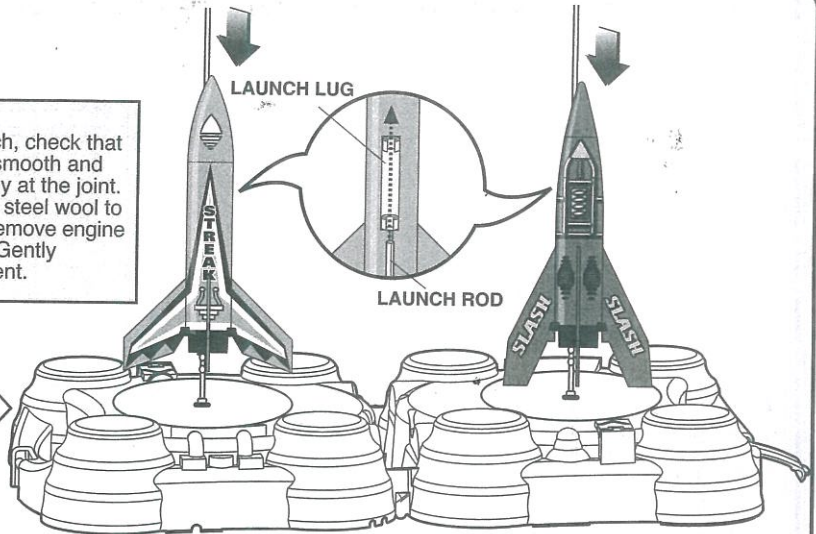

SLIDE ROCKETS DOWN OVER LAUNCH RODS.

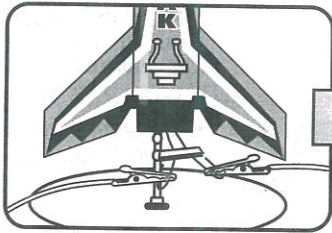

ATTACH MICRO-CLIPS TO IGNITERS.

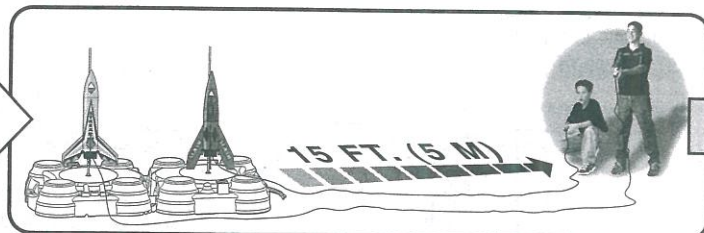

PREPARE TO LAUNCH. **EVERYONE MOVE BACK 15 FEET (5 M).**

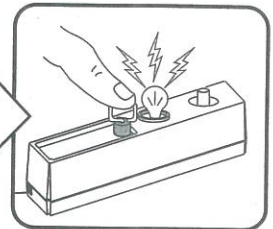

INSERT KEY. PUSH DOWN FIRMLY AND HOLD.



HOLD KEYS DOWN AND PRESS LAUNCH BUTTONS UNTIL LIFTOFF!

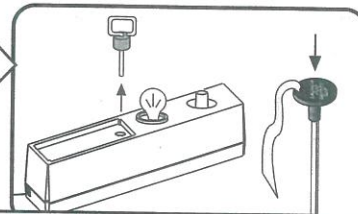

REMOVE SAFETY KEYS. REPLACE SAFETY CAPS ON LAUNCH RODS.

## DRAG RACING with ROCKETS RULES

A simple set of rules will help determine the winner of the race. In this event, two model rockets are launched at the same time from the dueling launch pad. A verbal countdown is used before launching and both launch buttons are pushed simultaneously when the command, "LAUNCH", is heard. Pushing the launch button before the LAUNCH command is issued will result in disqualification for that rocket. The rockets should use the same type of rocket engine, but the rockets may be different in shape and style. Each rocket must be successfully launched and safely recovered in order to qualify. If a rocket is lost during recovery, that rocket is disqualified.

### SCORING

- Ten points will be awarded to the rocket that moves first from the launch pad.
- Ten points will be awarded to the rocket that touches the ground last.
- Ten points will be awarded to the rocket landing closest to the launch pad.
- The rocket receiving the most points, without being disqualified, is the winner!

### IMPORTANT:

After launching and before inserting shock cord, streamer and nose cone into rocket body for your next flight, check the inside of the body at the nose cone end for engine residue. Use a moist cotton swab or tissue to remove the residue. Check nose cone fit. It should be snug but not tight.

## PRECAUTIONS

NAR Safety Code



NO DRY GRASS OR WEEDS

## PRE-LAUNCH CHECK

For safety, never launch a damaged rocket. Check the rocket's body, nose cone and fins. Also, check the engine mount, recovery system and launch lug(s). Repair any damage before launching the rocket. Should your rocket become deformed after launching, please return the rocket to Estes and we will send you two free replacement rockets.

## FLYING YOUR ROCKET

Choose a large field (250 ft. [76 m] square) free of dry weeds and brown grass. The larger the launch area, the better your chance of recovering your rocket. Football fields and playgrounds are great. Launch only with little or no wind and good visibility. Always follow the National Association of Rocketry (NAR) SAFETY CODE.

## MISFIRES

**TAKE THE KEY OUT OF THE CONTROLLER. WAIT ONE MINUTE BEFORE GOING NEAR THE ROCKET!** Disconnect the igniter clips and remove the engine. Take the plug and igniter out of the engine. If the igniter has burned, it worked but did not ignite the engine because it was not touching the propellant inside the engine. Put a new igniter all the way inside the engine without bending it. Push the plug in place. Repeat the steps under Countdown and Launch.