



Estes Industries  
1295 H Street  
Penrose, CO 81240  
PRINTED IN CHINA

# Air Power BLAST JETS™

Rocket Launched Airplanes!

#1861

## ASSEMBLY & OPERATING INSTRUCTIONS

Keep for future reference.

### ⚠ WARNING

High Powered Projectile - Striking Hazard.  
Not intended for children under 10 years old.

### Important Notice

The Air Power Blast Jets™ operate on powerful air pressure. Improper use of this product may result in personal injury or damage to the product. **READ AND FOLLOW THE INSTRUCTIONS AND AIR ROCKET SAFETY CODE BEFORE USING.**

### AIR ROCKET SAFETY CODE

- Never stand over rocket when launching.
- Keep away from your face when launching.
- Never point or launch rocket at people or animals.
- Use outdoors only in large open spaces.
- Do not fly near roads, power lines or trees.
- Keep spectators at least 15 feet (4.6 m) from launcher.
- Never launch any item except your Air Power Blast Jets™ rocket.

**ASSEMBLY TIP:** Read all instructions before beginning assembly. Assemble outdoors on level ground. Locate the parts shown below and lay them out in front of you. Check to make sure all parts are included, if any parts are missing, contact the Estes Customer Service Dept. at 800-525-7561, Mon. - Fri. 8:00 AM to 4:00 PM Mountain Time.

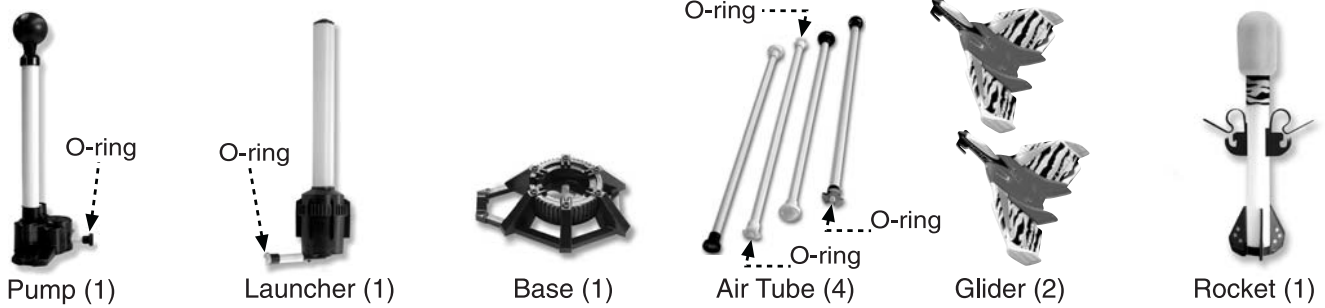

### LAUNCH SYSTEM SETUP

**Important:** Check to make sure o-rings are in place in the connectors.

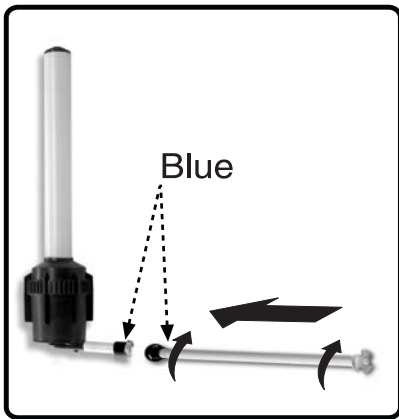

**1.** Attach air tube with blue connector to the launcher and twist connector hand tight.



**2.** Insert launcher with attached air tube into base.



**3.** Snap into place.

**IMPORTANT:** You should feel a "click" after twisting connectors together firmly. This ensures that the air tubes are sealed to prevent leakage.

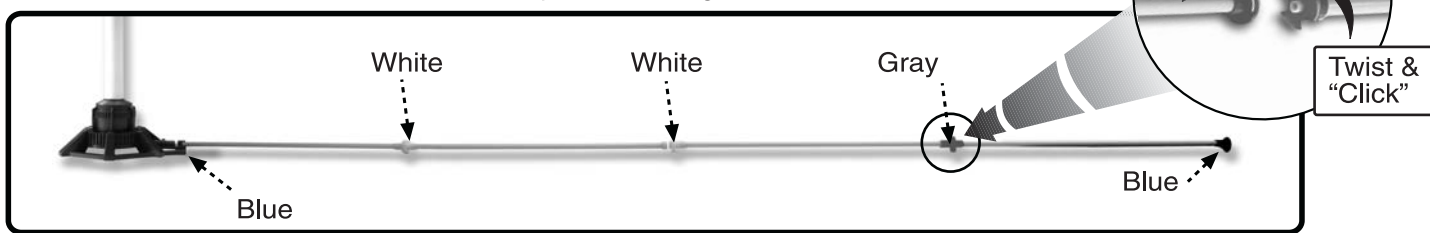

**4.** Attach remaining air tubes as shown, and twist connectors hand tight.

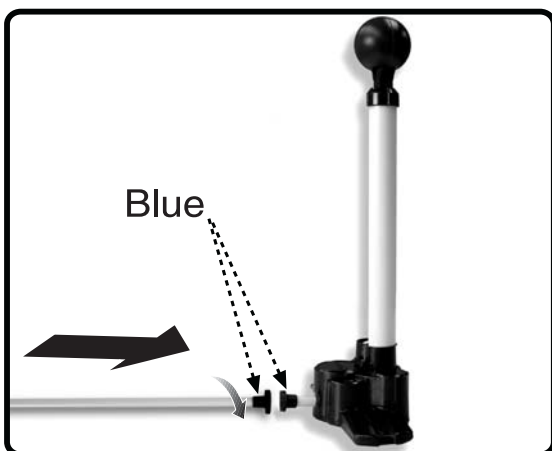

**5.** Attach air tube assembly to pump and twist connector hand tight.



Assembled launch system.

# LAUNCH SYSTEM OPERATION

**Important:** Move all spectators back 15 feet (4.6 m) from launcher.

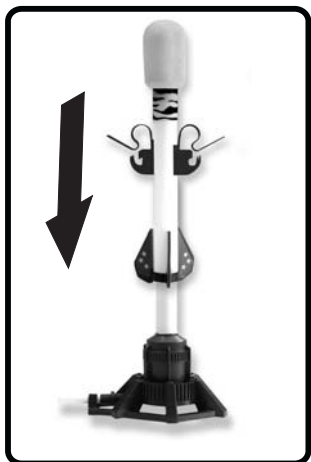

- 1.** Level base and slide rocket onto launcher.

**NOTE:** Launcher must be LEVEL or rocket will not launch.



- 2.** Position glider over spring and attach glider to rocket.

Then push glider up into groove to lock in place as shown. Repeat for other glider.



- 3.** Pump 15-25 times, or until you hear air release from the safety valve.

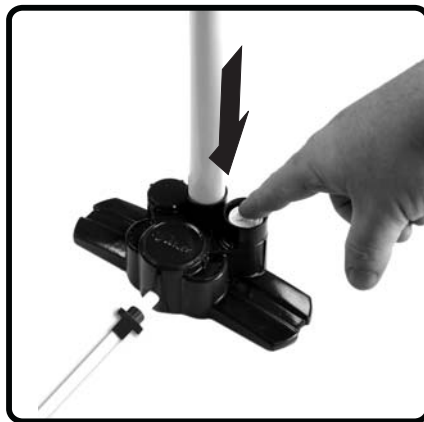

- 4.** Clear launch area of spectators. Countdown 5... 4... 3... 2... 1... press the launch button!

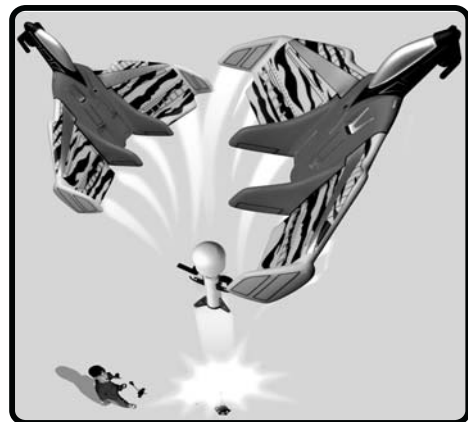

Watch the action!

## PRE-LAUNCH CHECK

For safety, never launch a damaged rocket. Check the rocket's body, nose cone and fins. If damaged, discontinue use of rocket and call the Estes Customer Service Department for a replacement. [800-525-7561 – Mon. - Fri. 8:00 AM to 4:00 PM Mountain Time]

## FLYING YOUR ROCKET

Choose a large field (250 ft. [76 m] square). The larger the launch area, the better the chance of recovering your rocket and gliders. Football fields and playgrounds are great. Launch only with little or no wind and good visibility. Do not launch near roads, buildings, power lines or trees. So that you don't lose sight of your jets or rocket, it's a good idea to have another person observe the launch and recovery, as the jets and rocket descend separately.

**Always read and follow the Air Rocket Safety Code.**



## FULL 90 DAY WARRANTY

Your Estes Air Power Blast Jets set is warranted against defects in materials or workmanship for a period of 90 days from the date of original purchase. Should this product, because of a manufacturing mistake, malfunction or prove to be defective within 90 days from the date of purchase, it will be repaired or replaced, at the option of Estes and at no charge to you, provided it is returned to Estes with proof of purchase.

This warranty does not cover incidental or consequential damage to persons or property caused by the use, abuse, misuse or failure to comply with operating instructions of the warranted product. Some states do not allow the exclusion or limitation of incidental or consequential damages, so the above exclusion may not apply to you. This warranty gives you specific legal rights and you may also have other rights, which vary from state to state.

For repair or replacement under this warranty, please return the defective part of your Estes product with proof of purchase to: Estes Industries, Customer Service Department, 1295 H Street, Penrose, Colorado 81240.

## ⚠ WARNING

Never launch the rocket when people are at launcher.

## ⚠ WARNING

Never stand over launcher at any time.

## ⚠ WARNING

Never use a rocket that is broken or missing its foam nose cone.