



www.estesrockets.com

ESTES-COX CORP.  
1295 H Street  
Penrose, CO 81240  
PRINTED IN CHINA

# COMANCHE-3™

## 3 STAGE HIGH ALTITUDE FLYING MODEL ROCKET KIT INSTRUCTIONS

KEEP FOR FUTURE REFERENCE

#1382

**ASSEMBLY TIP:** Read all instructions before beginning work on your model. Make sure you have all parts and supplies.

**TEST FIT ALL PARTS TOGETHER BEFORE APPLYING ANY GLUE!**

If any parts don't fit properly, sand as required for precision assembly.

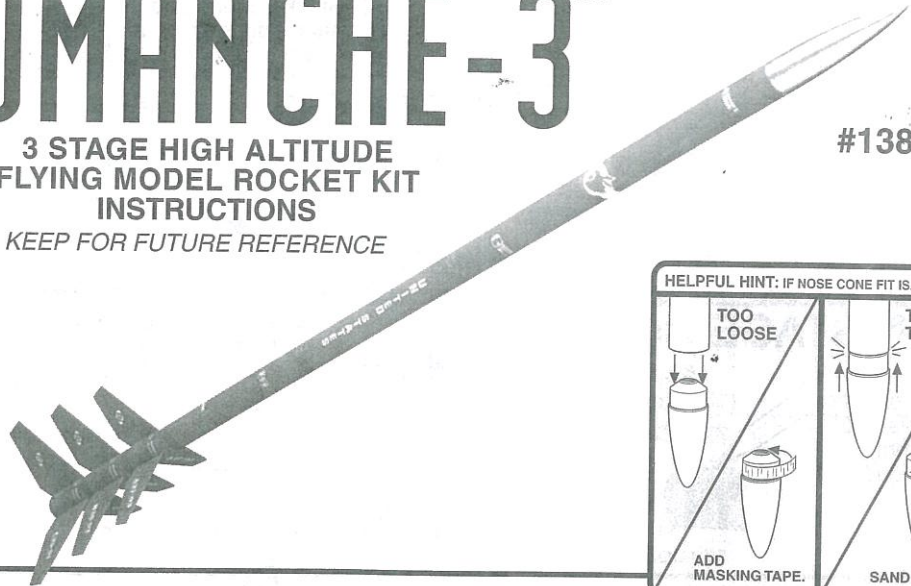

**PARTS** Locate the parts shown below and lay them out on the table in front of you. **DO NOT USE THIS DRAWING TO ASSEMBLE YOUR ROCKET.**

**BASE (1)** (72605)    **NOSE CONE (1)** (72604)    **LAUNCH LUG (1)** (38166)  
**ORANGE STREAMER (2)** (85697)    **GREEN THRUST RING (1)** (30162-2)  
**3RD STAGE EXTENSION BODY TUBE (1)** (30366)    **BT-50 12.7" (32.3 cm)**  
**SHOCK CORD RUBBER (1)** (38366)    **BT-50 18" (45.7 cm)**    **YELLOW SPACER TUBE (1)** (35003)  
**3RD STAGE BODY TUBE (1)** (30352)    **BT-20 2.25" (5.7 cm)**    **3RD STAGE ENGINE MOUNT TUBE (1)** (30408)  
**Decal Sheet (1)** (37524)    **1ST AND 2ND STAGE BODY TUBES (2)** (30362)    **2ND STAGE ENGINE MOUNT TUBE (1)** (30334)  
**Green Centering Rings (4)** (30164-2)    **RED TUBE COUPLERS (3)** (30174-5)  
**Laser Cut Balsa Sheet (1)** (32392)

**SUPPLIES** In addition to the parts included in the kit you will also need:

SCISSORS	PENCIL	RULER	CARPENTER'S GLUE	MODELING KNIFE	PLASTIC CEMENT	SPRAY PRIMER (WHITE)	SPRAY PAINT (SILVER & BRIGHT ORANGE)	CLEAR SPRAY PRIMER (OPTIONAL)	MASKING TAPE	FINE SANDPAPER	CELLOPHANE TAPE

1.

A. Fine sand balsa sheet.

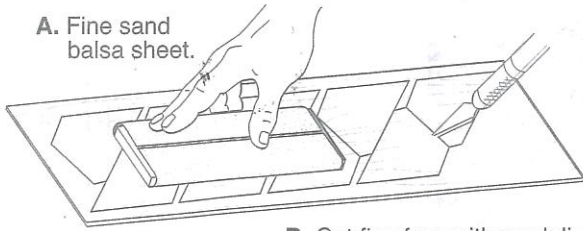

B. Cut fins free with modeling knife.

C. Stack like fins and sand edges smooth.

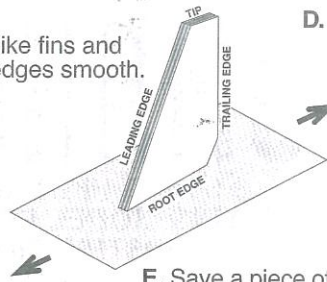

D. Round leading edges.

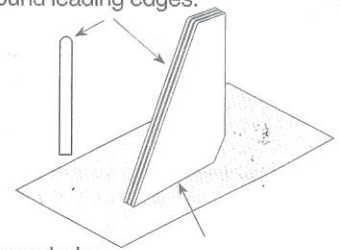

E. Save a piece of scrap balsa to use as a glue applicator.

ROOT EDGE GLUES TO BODY TUBE.

## 2. 1<sup>ST</sup> STAGE BODY

A. Mark one red coupler 1/2" (13 mm) from end.

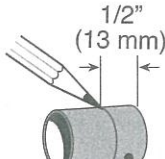

RED COUPLER

B. Apply glue just inside one end of body tube and insert coupler to 1/2" (13 mm) mark. Let dry.

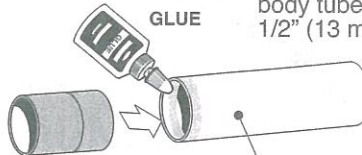

1<sup>ST</sup> STAGE BODY TUBE  
1" (25 mm) DIA. x 2 3/4" (70 mm) LONG

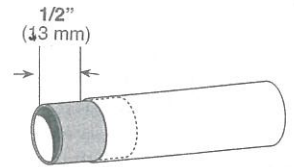

C. Completed 1st stage body tube.

## 3. 2<sup>ND</sup> STAGE BODY

A. Mark engine mount tube 3/4" (19 mm) from end.

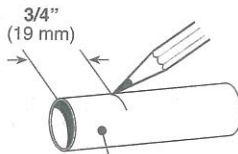

2<sup>ND</sup> STAGE ENGINE MOUNT TUBE  
3/4" (19 mm) DIA. x 2 1/4" (57 mm) LONG

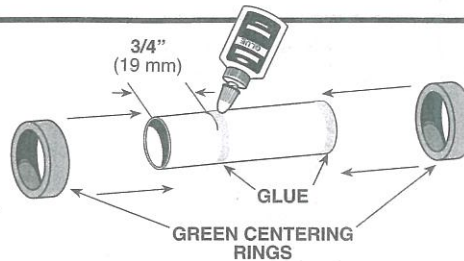

B. Apply glue just past 3/4" (19 mm) mark and at end of tube as shown.

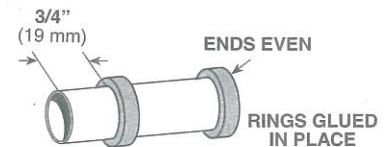

C. Slide green centering rings in place as shown. Let dry.

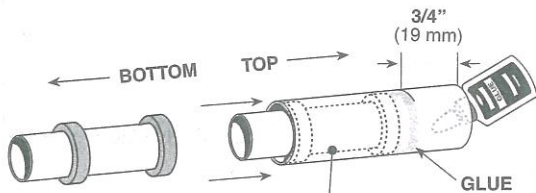

BODY TUBE 1" (25 mm) DIA. x 2 3/4" (7.0 cm) LONG

D. Apply glue 3/4" (19 mm) inside remaining BT-50 body tube and insert engine mount assembly until flush (ends even).

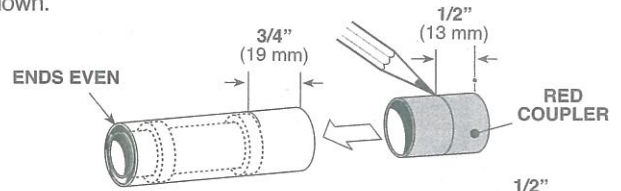

E. Mark red coupler 1/2" (13 mm) from end. Apply glue inside end of body tube and insert coupler to 1/2" (13 mm) mark. Let dry.

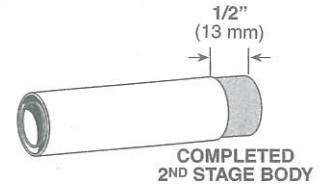

COMPLETED 2<sup>ND</sup> STAGE BODY

## 4. 3<sup>RD</sup> STAGE BODY

3/4" (19 mm)

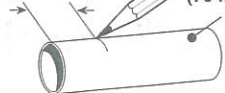

A. Mark engine mount tube.

3<sup>RD</sup> STAGE ENGINE MOUNT TUBE  
3/4" (19 mm) DIA. x 2 3/4" (70 mm) LONG

B. Glue green centering rings.

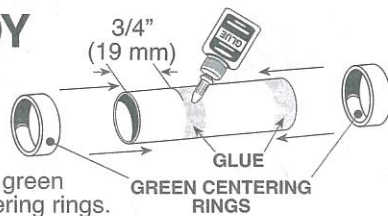

3/4" (19 mm)

ENDS EVEN  
RINGS GLUED IN PLACE

C. Mark yellow spacer tube 1/2" (13 mm) from end.

D. Apply glue 3/4" (19 mm) inside engine mount from front.

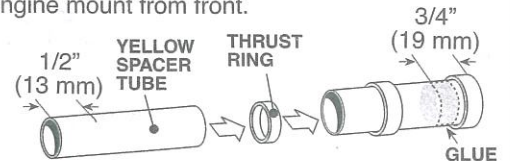

E. Insert green thrust ring, then yellow spacer tube until 1/2" (13 mm) mark is even with end of tube. Remove spacer tube immediately. Let dry.

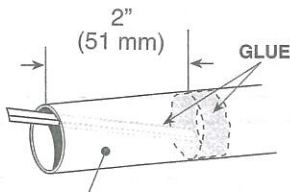
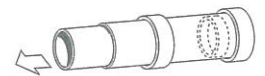

3<sup>RD</sup> STAGE BODY TUBE 18" (45.7 cm) LONG

F. Use a piece of scrap balsa to smear glue 2" (51 mm) inside body tube.

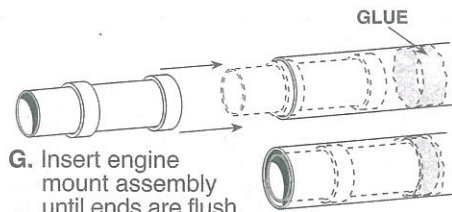

G. Insert engine mount assembly until ends are flush.

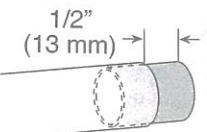
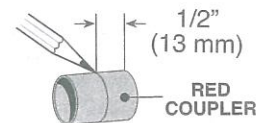

F. Glue coupler into front of body tube (opposite end of engine mount assembly).



5.

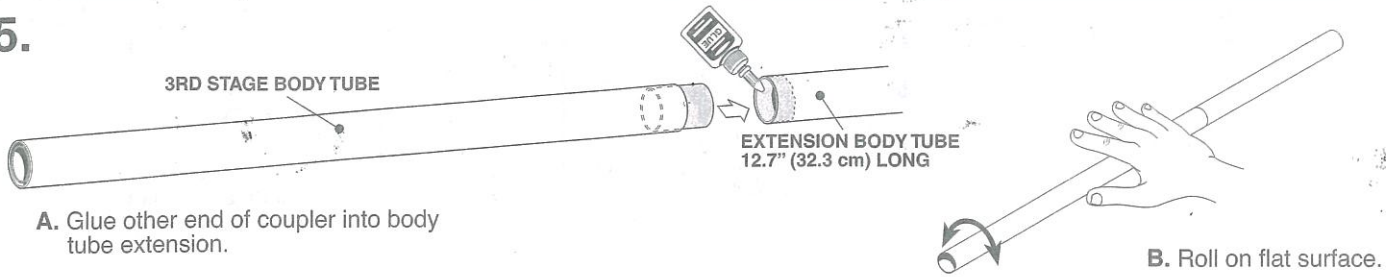

6.

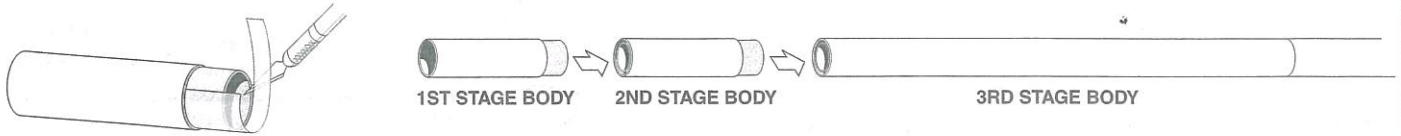

7.

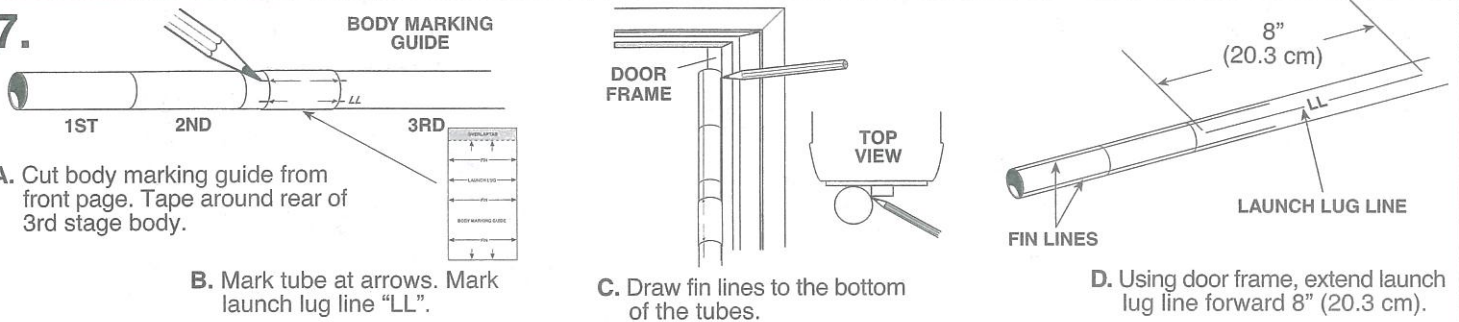

8.

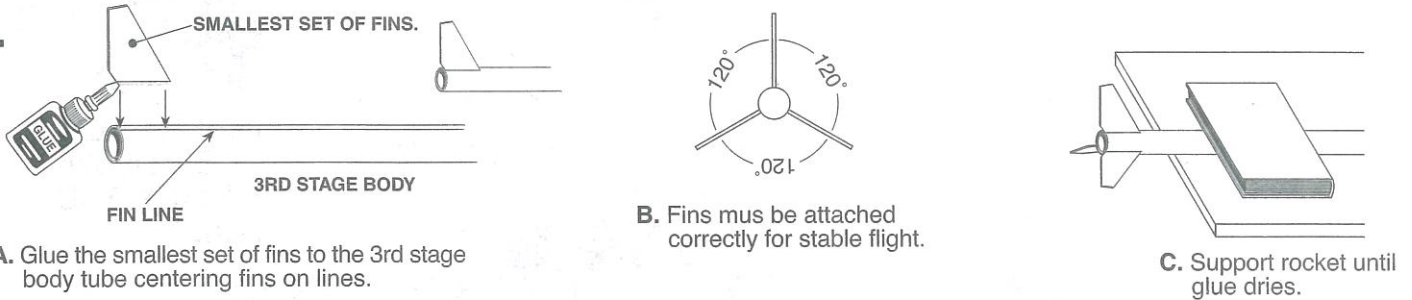

9.

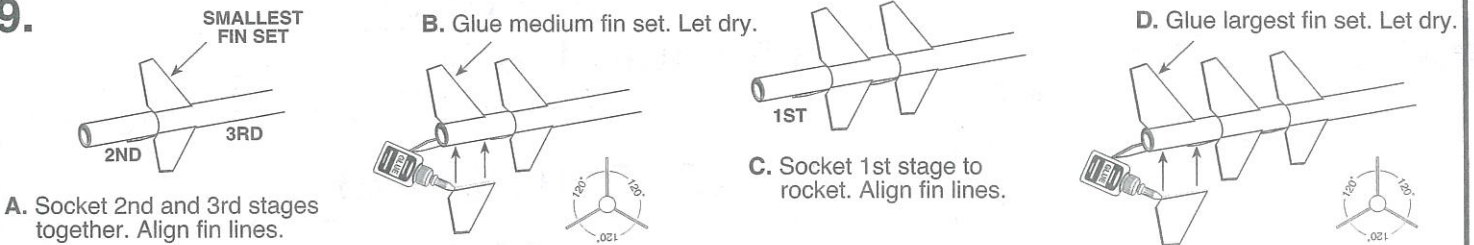

10.

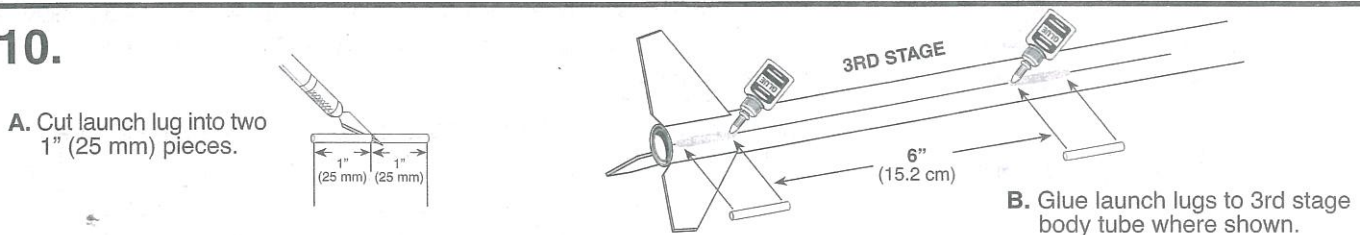

# 11.

A. Proceed with this step only after glue on fins and launch lugs is thoroughly dry.

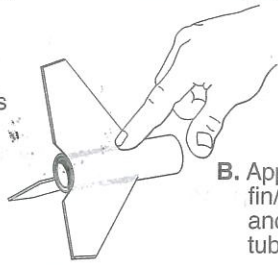

B. Apply glue fillets to all fin/body tube joints and launch lug/body tube joints.

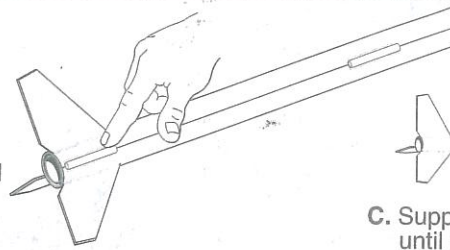

C. Support rocket until glue dries.

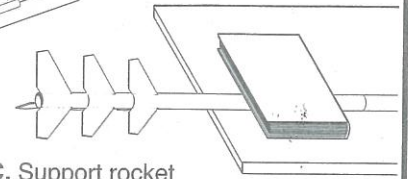

# 12.

A. Apply a ring of plastic cement inside nose cone. Insert base. Let dry.

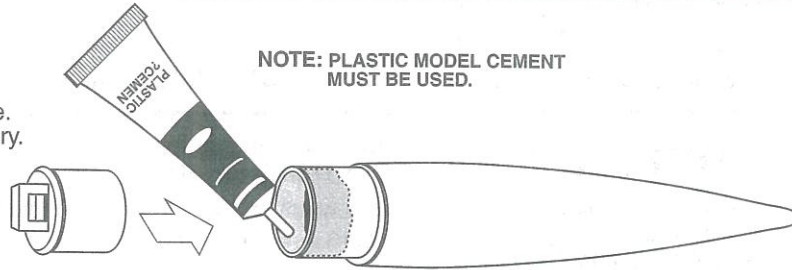

NOTE: PLASTIC MODEL CEMENT MUST BE USED.

# 13.

A. Cut out shock cord mount from front page.



B. Fold.



SHOCK CORD

C. Apply glue. Fold forward.

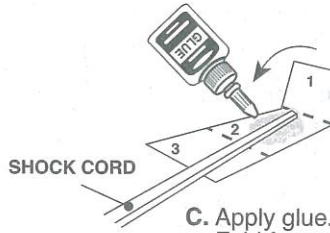

D. Apply glue. Fold forward.

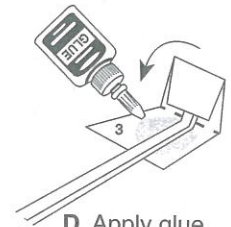

E. Squeeze tightly and hold for one minute.

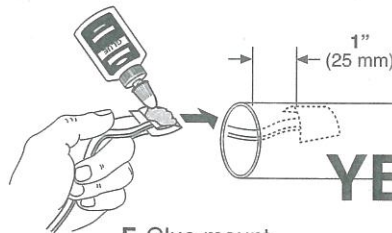

F. Glue mount 1" (25 mm) inside the front of 3rd stage body tube. Hold until glue sets. Let dry.

YES



NO

# 14.

A. Attach shock cord to nose cone with a double knot.

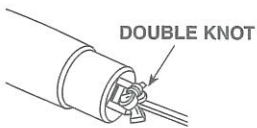

B. Tie streamers to cord where shown using a double knot.

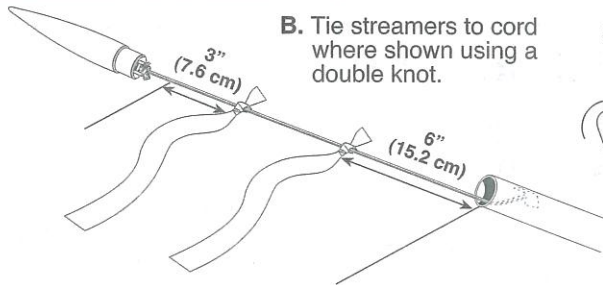

C. Roll streamers.

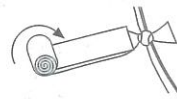

D. Insert into body tube.

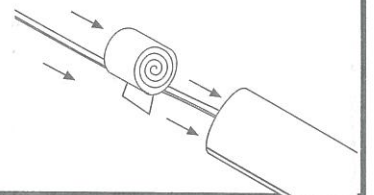

# 15.

A. Spray primer on fins and body tube. Let dry. Sand.

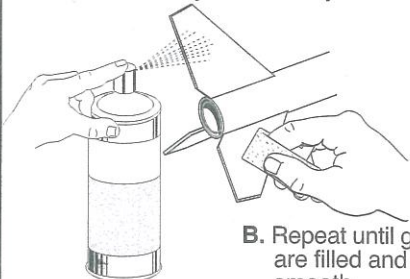

SPLIT YELLOW SPACERTUBE TO HOLD NOSE CONE.

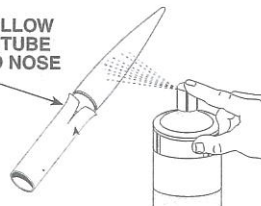

C. Paint nose cone silver.

ROLLED PAPER

D. Paint body and fins bright orange using several mist coats.

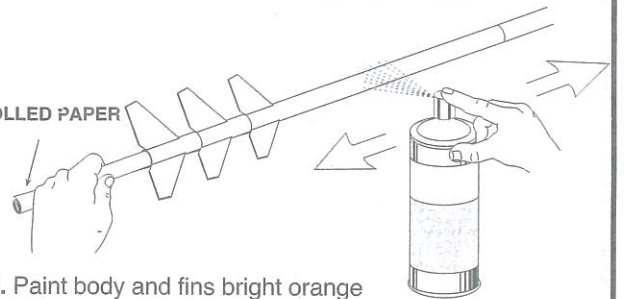



# DECAL APPLICATION

- Apply green body bands first. Three narrow bands are applied to the tops of 1st, 2nd, and 3rd stage bodies. Bands should be even with the tops of the bodies.
- Apply remaining bands to 3rd stage at dimensions shown.
- Use the kit panel photo as a guide to apply remaining decals.
- To apply water transfer decal, cut out an individual section of the decal and dip in lukewarm water for about 10 seconds (one section at a time).
- When decal slides freely away from the backing paper, slip it onto the model and position it in place.
- Use a napkin or tissue to blot away any excess water and allow the decal to dry completely.
- Repeat process for remaining decal sections.
- Apply engine stickers from decal sheet to each body tube as a reference.

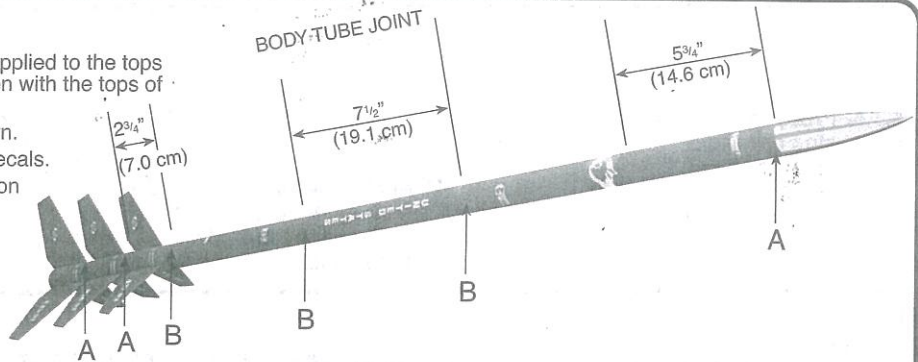

**OPTIONAL:** Clear coat entire rocket when complete.

# FLYING THE COMANCHE-3™

The Comanche-3™ is a 3 stage rocket that may be launched in several configurations. In addition to the full 3 stage configuration, it may be flown as a 2 stage rocket using the first and third or the second and third stages. In addition, the third stage may be flown as a single stage rocket. The first stage uses a "D" engine and the second and third stages use standard engines. Use of the most powerful engine combination (D12-0, C6-0, C6-7) produces extremely high flights. For this reason, the above engine combination should only be used on very calm days. It is also advisable to have observers present during a multi-stage launch. Each observer can track one stage to ensure recovery. When separated from the rocket, the 1st and 2nd stages tumble end over end to a gentle landing. The third stage uses two streamers to slow its descent. The streamers produce less drift than would a parachute. Because of the high altitude, however, it is important to carefully track the descent of the third stage (preferably by two observers).

To launch the Comanche-3™ you will need the following items: (SOLD SEPARATELY)

- An Estes® Porta-Pad®II Launch Pad and Electron Beam® Controller
- 3/16 in. (5 mm) Maxi™ Rod (302244)
- Recovery Wadding (302274)
- Estes® Engines (listed below), igniters and igniter plugs.

3 STAGE LAUNCHES			2 STAGE LAUNCHES (using 2nd & 3rd stages)		SINGLE STAGE LAUNCHES
1st Stage	2nd Stage	3rd Stage	2nd Stage	3rd Stage	3rd Stage
C11-0	B6-0	B6-6	C6-0	A8-3	A8-3
D12-0	C6-0	C6-7		B4-4	B4-4
				B6-4	B6-4
				C6-5	C6-5
			(using 1st & 3rd stages)		
			1st Stage	3rd Stage	
			D12-0	B6-6	
				C6-7	

USE ONLY WITH ESTES PRODUCTS.

SAVE THIS CHART FOR REFERENCE.

# STREAMER PACKOUT

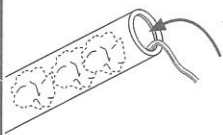

A. Insert 3 - 4 squares of loosely crumpled recovery wadding into body tube.

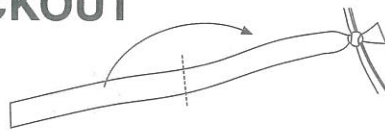

B. Fold streamers in half.



C. Roll streamers.

D. Insert streamers, shock cord and nose cone into body tube.

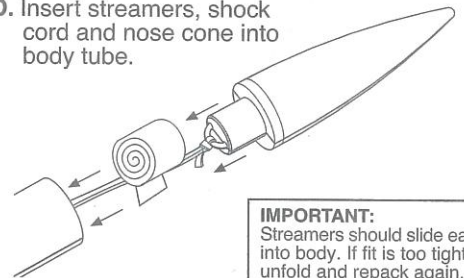

**IMPORTANT:** Streamers should slide easily into body. If fit is too tight, unfold and repack again.

**IMPORTANT:** Wadding must be in place and slide freely for rocket to work properly.

**NOTE:** Only Estes Wadding (302274) Recommended.

# 2ND AND 3RD STAGE ENGINE PREP

A. Wrap cellophane tape around joint.

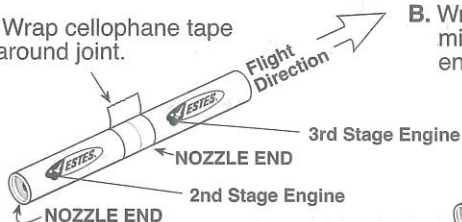

B. Wrap masking tape around middle of each engine to ensure tight fit in rocket.

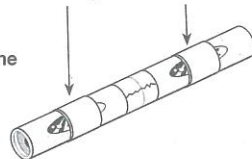

C. Insert engine into 3rd stage body. If too tight, remove some tape. If too loose, add tape. Engines must not eject during flight.

D. Engine should project out 1/2" (13 mm) from end.

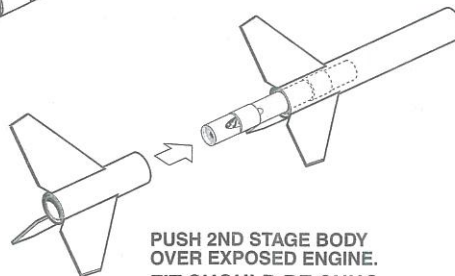

PUSH 2ND STAGE BODY OVER EXPOSED ENGINE. FIT SHOULD BE SNUG.

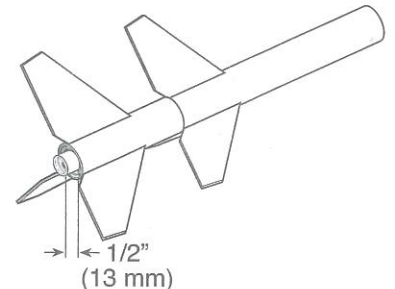

## WARNING: FLAMMABLE

To avoid serious injury, read instructions & NAR Safety Code included with engines. **PREPARE ENGINE ONLY WHEN YOU ARE OUTSIDE AT THE LAUNCH SITE PREPARING TO LAUNCH!** If you do not use your prepared engine, remove the igniter before storing engine.



# 1<sup>ST</sup> STAGE ENGINE PREP

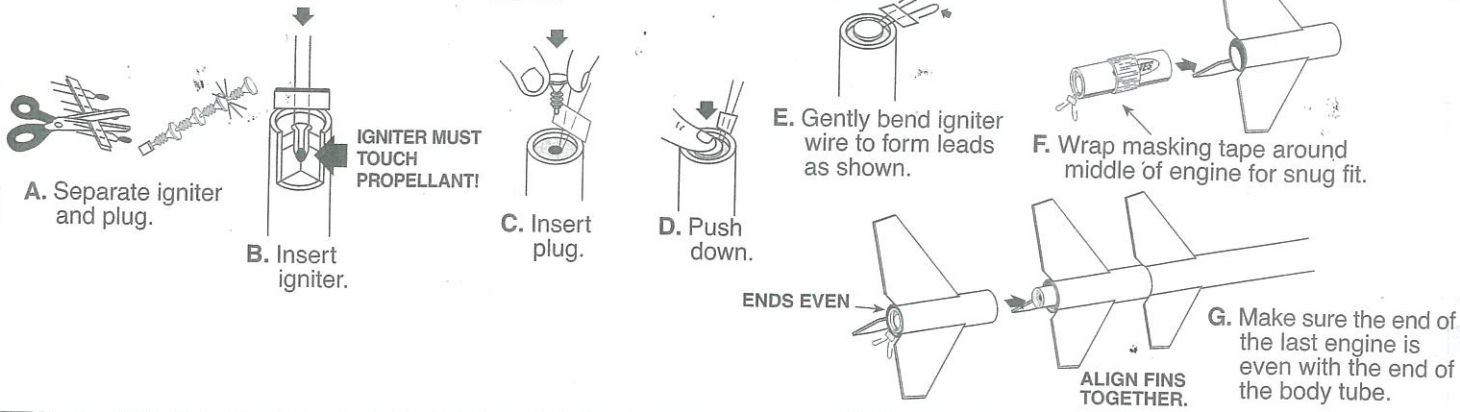

# COUNTDOWN AND LAUNCH

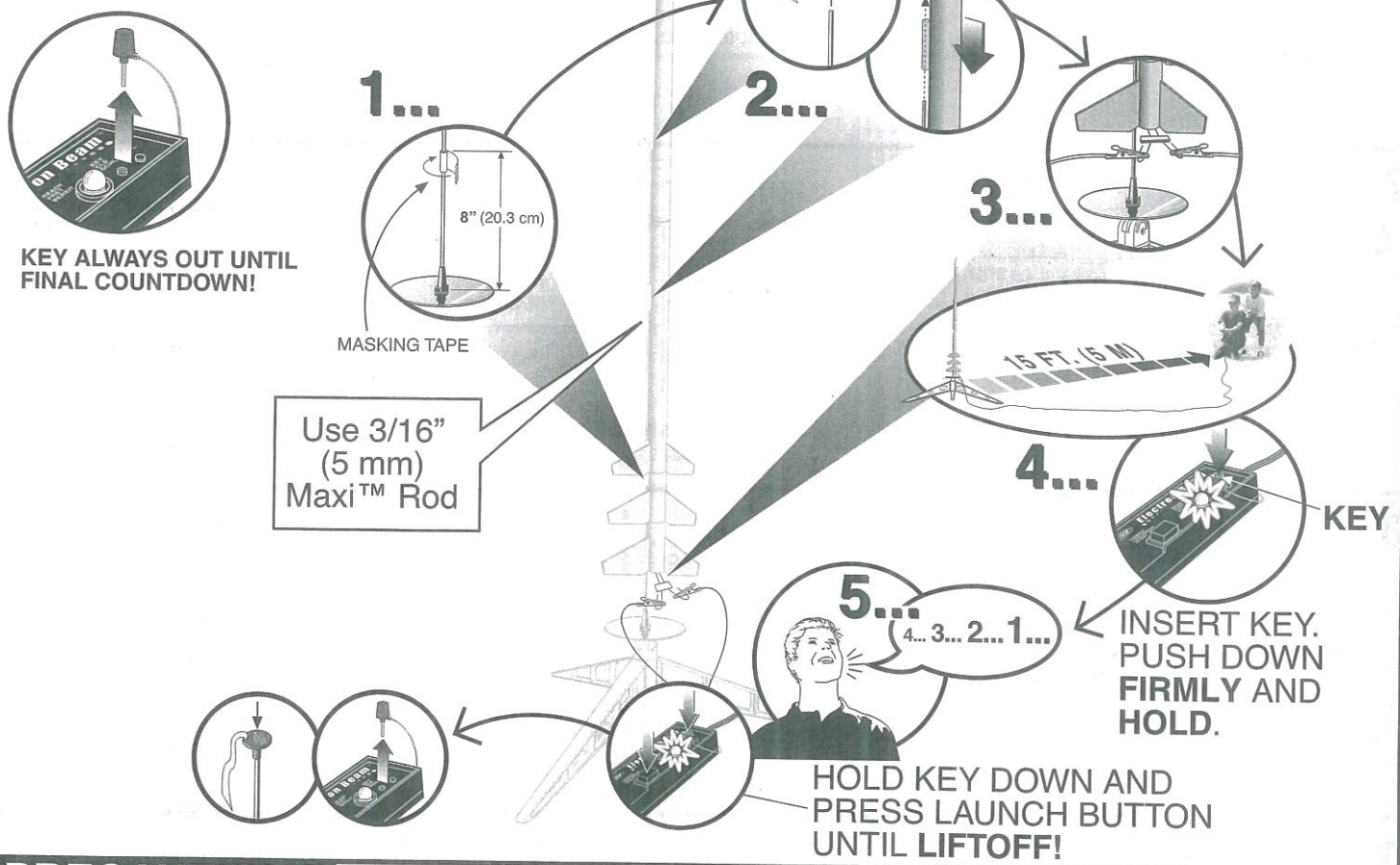

## PRECAUTIONS

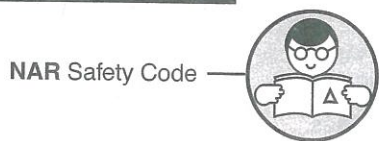

## PRE-LAUNCH CHECK

For safety, never launch a damaged rocket. Check the rocket's body, nose cone and fins. Also, check the engine mount, recovery system and launch lug(s). Repair any damage before launching the rocket.

## FLYING YOUR ROCKET

Choose a large field (500 ft. [152 m] square) free of dry weeds and brown grass. The larger the launch area, the better your chance of recovering your rocket. Football fields and playgrounds are great. Launch only with little or no wind and good visibility. Always follow the National Association of Rocketry (NAR) SAFETY CODE.

## MISFIRES

**TAKE THE KEY OUT OF THE CONTROLLER. WAIT ONE MINUTE BEFORE GOING NEAR THE ROCKET!** Disconnect the igniter clips and remove engine. Take the plug and igniter out of the engine. If the igniter has burned, it worked but did not ignite the engine because it was not touching the propellant inside the engine. Put a new igniter all the way inside the engine without bending it. Push the plug in place. Repeat the steps under Countdown and Launch.